

MITSUBISHI HVIGBT MODULES
CM800HA-50H

HVIGBT (High Voltage Insulated Gate Bipolar Transistor) Modules

HIGH POWER SWITCHING USE
 INSULATED TYPE

CM800HA-50H



- IC.....800A
- VCES 2500V
- Insulated Type
- 1-element in a pack

APPLICATION

Inverters, Converters, DC choppers, Induction heating, DC to DC converters.

OUTLINE DRAWING & CIRCUIT DIAGRAM

Dimensions in mm

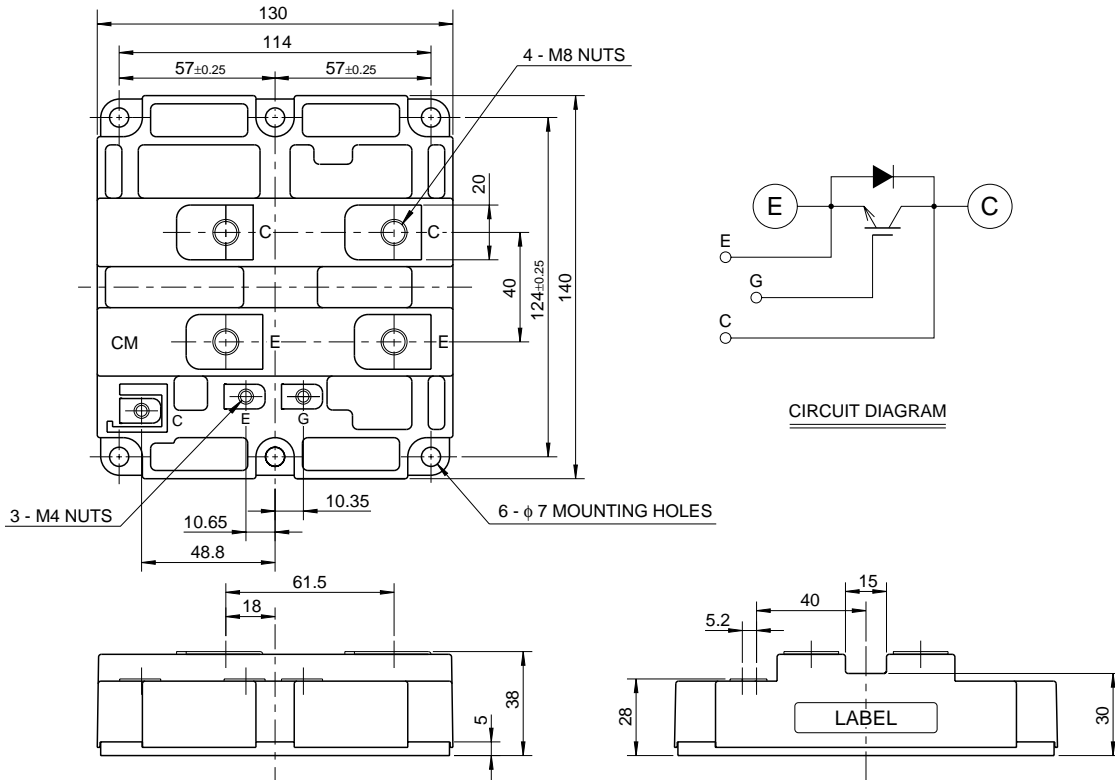

HVIGBT MODULES (High Voltage Insulated Gate Bipolar Transistor Modules)

Mar. 2003

CM800HA-50H

**HIGH POWER SWITCHING USE
INSULATED TYPE**

HVIGBT (High Voltage Insulated Gate Bipolar Transistor) Modules

MAXIMUM RATINGS (T_j = 25°C)

| Symbol | Item | Conditions | Ratings | Unit |
|--------------------------|-------------------------------|--|--------------|------|
| V _{CE} S | Collector-emitter voltage | V _{GE} = 0V | 2500 | V |
| V _{GE} S | Gate-emitter voltage | V _{CE} = 0V | ±20 | V |
| I _C | Collector current | DC, T _C = 80°C | 800 | A |
| I _{CM} | | Pulse (Note 1) | 1600 | A |
| I _E (Note 2) | Emitter current | | 800 | A |
| I _{EM} (Note 2) | | Pulse (Note 1) | 1600 | A |
| P _C (Note 3) | Maximum collector dissipation | T _C = 25°C, IGBT part | 6900 | W |
| T _j | Junction temperature | — | -40 ~ +150 | °C |
| T _{stg} | Storage temperature | — | -40 ~ +125 | °C |
| V _{iso} | Isolation voltage | Charged part to base plate, rms, sinusoidal, AC 60Hz 1min. | 6000 | V |
| — | Mounting torque | Main terminals screw M8 | 6.67 ~ 13.00 | N·m |
| | | Mounting screw M6 | 2.84 ~ 6.00 | N·m |
| | | Auxiliary terminals screw M4 | 0.88 ~ 2.00 | N·m |
| — | Mass | Typical value | 1.5 | kg |

ELECTRICAL CHARACTERISTICS (T_j = 25°C)

| Symbol | Item | Conditions | Limits | | | Unit |
|--------------------------|--------------------------------------|---|--------|-------|-------|------|
| | | | Min | Typ | Max | |
| I _{CES} | Collector cutoff current | V _{CE} = V _{CE} S, V _{GE} = 0V | — | — | 10 | mA |
| V _{GE(th)} | Gate-emitter threshold voltage | I _C = 80mA, V _{CE} = 10V | 4.5 | 6.0 | 7.5 | V |
| I _{GES} | Gate-leakage current | V _{GE} = V _{GES} , V _{CE} = 0V | — | — | 0.5 | µA |
| V _{CE(sat)} | Collector-emitter saturation voltage | T _j = 25°C | — | 3.20 | 4.16 | V |
| | | T _j = 125°C | — | 3.60 | — | |
| C _{ies} | Input capacitance | V _{CE} = 10V V _{GE} = 0V | — | 80 | — | nF |
| C _{oes} | Output capacitance | | — | 8.8 | — | nF |
| C _{res} | Reverse transfer capacitance | | — | 2.7 | — | nF |
| Q _G | Total gate charge | V _{CC} = 1250V, I _C = 800A, V _{GE} = 15V | — | 3.6 | — | µC |
| t _{d(on)} | Turn-on delay time | V _{CC} = 1250V, I _C = 800A | — | — | 1.60 | µs |
| t _r | Turn-on rise time | V _{GE1} = V _{GE2} = 15V | — | — | 2.00 | µs |
| t _{d(off)} | Turn-off delay time | R _G = 3.75Ω | — | — | 2.50 | µs |
| t _f | Turn-off fall time | Resistive load switching operation | — | — | 1.00 | µs |
| V _{EC} (Note 2) | Emitter-collector voltage | I _E = 800A, V _{GE} = 0V | — | 2.90 | 3.77 | V |
| t _{rr} (Note 2) | Reverse recovery time | I _E = 800A | — | — | 1.20 | µs |
| Q _{rr} (Note 2) | Reverse recovery charge | die / dt = -1600A / µs | — | 170 | — | µC |
| R _{th(j-c)Q} | Thermal resistance | Junction to case, IGBT part | — | — | 0.018 | K/W |
| R _{th(j-c)R} | | Junction to case, FWDi part | — | — | 0.036 | K/W |
| R _{th(c-f)} | Contact thermal resistance | Case to fin, conductive grease applied | — | 0.008 | — | K/W |

- Note 1. Pulse width and repetition rate should be such that the device junction temp. (T_j) does not exceed T_{jmax} rating.
 2. I_E, V_{EC}, t_{rr}, Q_{rr} & die/dt represent characteristics of the anti-parallel, emitter to collector free-wheel diode.
 3. Junction temperature (T_j) should not increase beyond 150°C.
 4. Pulse width and repetition rate should be such as to cause negligible temperature rise.

CM800HA-50H

HIGH POWER SWITCHING USE
INSULATED TYPE

HVIGBT (High Voltage Insulated Gate Bipolar Transistor) Modules

PERFORMANCE CURVES

OUTPUT CHARACTERISTICS (TYPICAL)

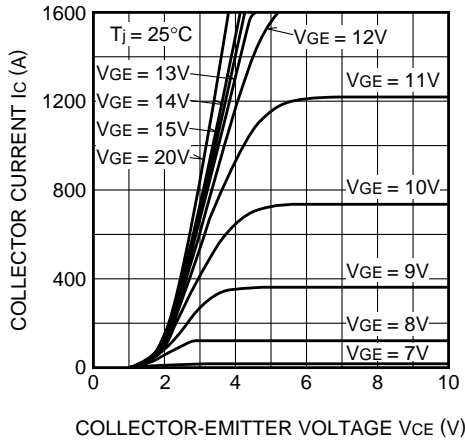

TRANSFER CHARACTERISTICS (TYPICAL)

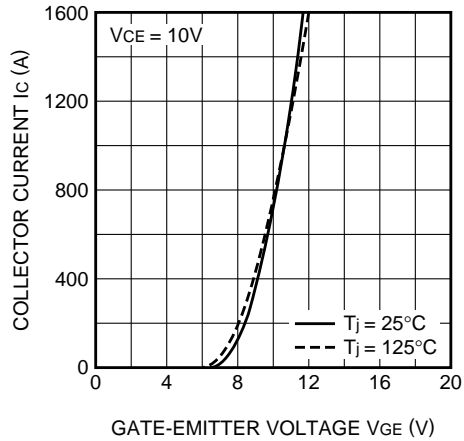

COLLECTOR-EMITTER SATURATION VOLTAGE CHARACTERISTICS (TYPICAL)

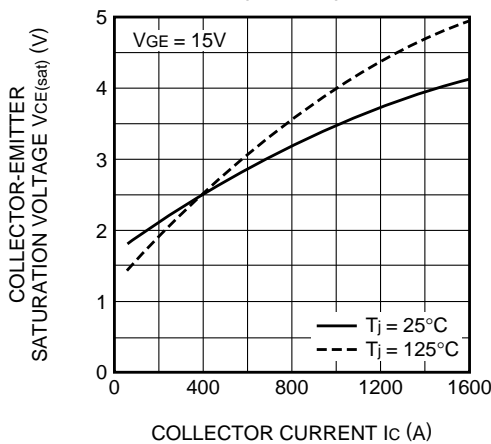

COLLECTOR-EMITTER SATURATION VOLTAGE CHARACTERISTICS (TYPICAL)

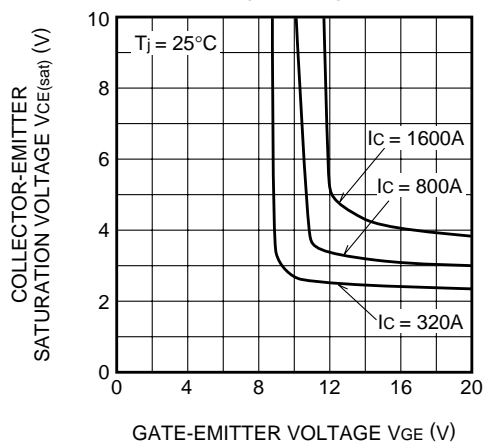

FREE-WHEEL DIODE FORWARD CHARACTERISTICS (TYPICAL)

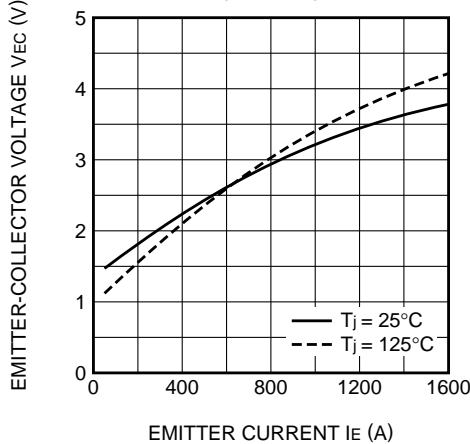

CAPACITANCE CHARACTERISTICS (TYPICAL)

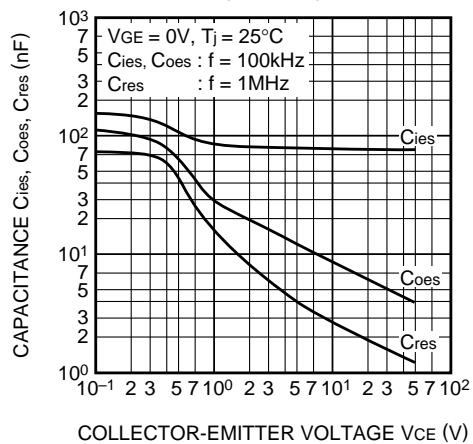

CM800HA-50H

HIGH POWER SWITCHING USE
INSULATED TYPE

HVIGBT (High Voltage Insulated Gate Bipolar Transistor) Modules

HALF-BRIDGE SWITCHING TIME CHARACTERISTICS (TYPICAL)

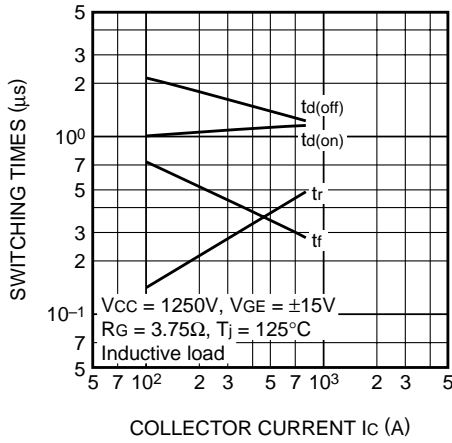

REVERSE RECOVERY CHARACTERISTICS OF FREE-WHEEL DIODE (TYPICAL)

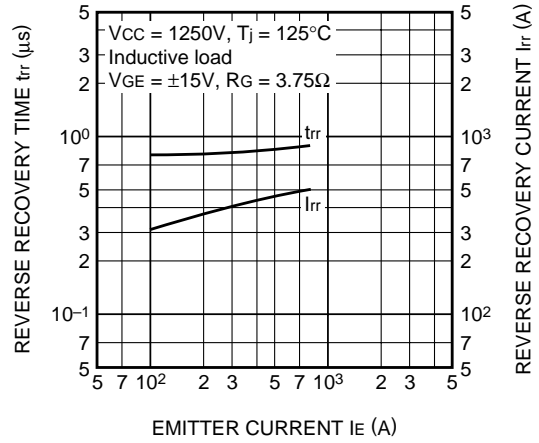

HALF-BRIDGE SWITCHING ENERGY CHARACTERISTICS (TYPICAL)

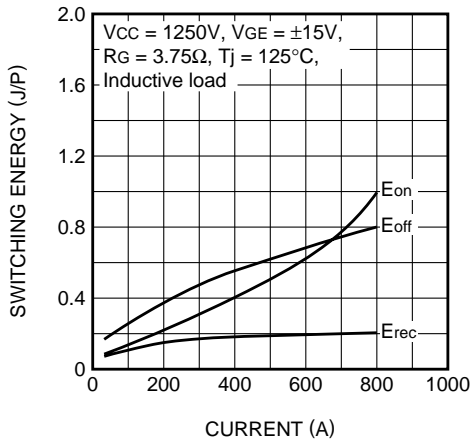

HALF-BRIDGE SWITCHING ENERGY CHARACTERISTICS (TYPICAL)

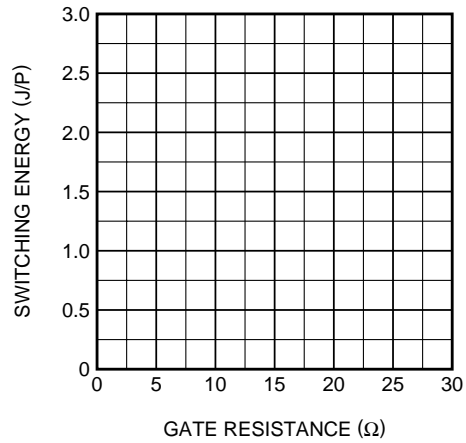

GATE CHARGE CHARACTERISTICS (TYPICAL)

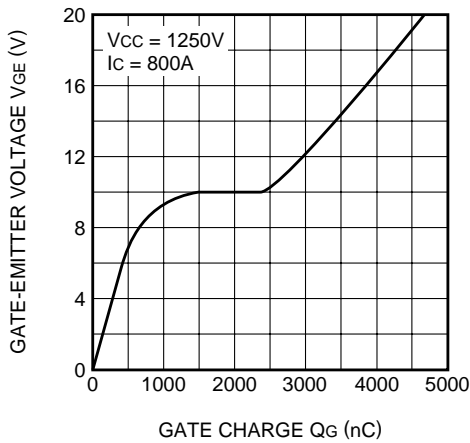

TRANSIENT THERMAL IMPEDANCE CHARACTERISTICS

