

SKiiP 2013 GB172-4DW V3

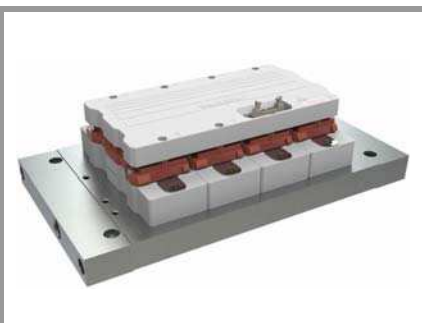

SKiiP® 3

2-pack-integrated intelligent Power System

SKiiP 2013 GB172-4DW V3

Features

- SKiiP technology inside
- Trench IGBTs
- CAL diode technology
- Integrated current sensor
- Integrated temperature sensor
- Integrated heat sink
- UL recognized File no. E63532

Typical Applications*

- Renewable energies
- Traction
- Elevators
- Industrial drives

Footnotes

¹⁾ With assembly of suitable MKP capacitor per terminal

Absolute Maximum Ratings		$T_s = 25^\circ\text{C}$ unless otherwise specified	
Symbol	Conditions	Values	Unit
System			
$V_{CC}^{1)}$	Operating DC link voltage	1200	V
V_{isol}	DC, $t = 1\text{ s}$, main terminals to heat sink	5600	V
$I_{t(RMS)}$	per AC terminal, $T_{terminal} < 115^\circ\text{C}$	400	A
I_{FSM}	$T_j = 150^\circ\text{C}$, $t_p = 10\text{ ms}$, $\sin 180^\circ$	13500	A
I^2t	$T_j = 150^\circ\text{C}$, $t_p = 10\text{ ms}$, diode	911	kA^2s
f_{out}	fundamental output frequency	1	kHz
T_{stg}	storage temperature	-40 ... 85	$^\circ\text{C}$

IGBT				
V_{CES}	$T_j = 25^\circ\text{C}$	1700	V	
I_C	$T_j = 150^\circ\text{C}$	$T_s = 25^\circ\text{C}$	2102	A
		$T_s = 70^\circ\text{C}$	1617	A
I_{Cnom}		2000	A	
T_j	junction temperature	-40 ... 150	$^\circ\text{C}$	

Diode				
V_{RRM}	$T_j = 25^\circ\text{C}$	1700	V	
I_F	$T_j = 150^\circ\text{C}$	$T_s = 25^\circ\text{C}$	1758	A
		$T_s = 70^\circ\text{C}$	1338	A
I_{Fnom}		1650	A	
T_j	junction temperature	-40 ... 150	$^\circ\text{C}$	

Driver			
V_s	power supply	13 ... 30	V
V_{iH}	input signal voltage (high)	15 + 0.3	V
$V_{isolIPD}$	QPD $\leq 10\text{pC}$, PRIM to POWER	1500	V
dv/dt	secondary to primary side	75	$\text{kV}/\mu\text{s}$
f_{sw}	switching frequency	7	kHz

Characteristics		$T_s = 25^\circ\text{C}$ unless otherwise specified			
Symbol	Conditions	min.	typ.	max.	Unit
IGBT					
$V_{CE(sat)}$	$I_C = 1200\text{ A}$ at terminal	$T_j = 25^\circ\text{C}$	1.9	2.4	V
		$T_j = 125^\circ\text{C}$	2.2		V
V_{CE0}		$T_j = 25^\circ\text{C}$	1.00	1.20	V
		$T_j = 125^\circ\text{C}$	0.90	1.10	V
r_{CE}	at terminal	$T_j = 25^\circ\text{C}$	0.75	0.95	$\text{m}\Omega$
		$T_j = 125^\circ\text{C}$	1.1	1.3	$\text{m}\Omega$
$E_{on} + E_{off}$	$I_C = 1200\text{ A}$ $T_j = 125^\circ\text{C}$	$V_{CC} = 900\text{ V}$	780		mJ
		$V_{CC} = 1200\text{ V}$	1150		mJ
$R_{th(j-s)}$	per IGBT switch			0.015	K/W
$R_{th(j-r)}$	per IGBT switch			0.0175	K/W

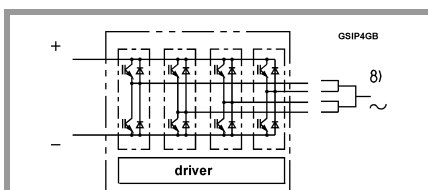

S43

SKiiP 2013 GB172-4DW V3

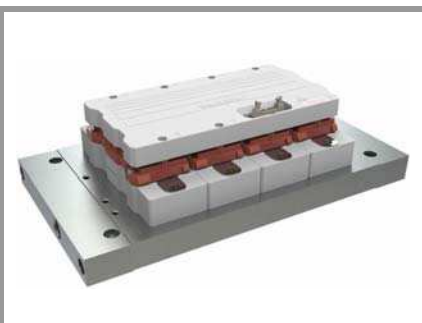

SKiiP® 3

2-pack-integrated intelligent Power System

SKiiP 2013 GB172-4DW V3

Features

- SKiiP technology inside
- Trench IGBTs
- CAL diode technology
- Integrated current sensor
- Integrated temperature sensor
- Integrated heat sink
- UL recognized File no. E63532

Typical Applications*

- Renewable energies
- Traction
- Elevators
- Industrial drives

Footnotes

¹⁾ With assembly of suitable MKP capacitor per terminal

Characteristics		$T_s = 25^\circ\text{C}$ unless otherwise specified			
Symbol	Conditions	min.	typ.	max.	Unit
Diode					
$V_F = V_{EC}$	$I_F = 1200\text{ A}$ at terminal	$T_j = 25^\circ\text{C}$	2.00	2.15	V
		$T_j = 125^\circ\text{C}$	1.80		V
V_{F0}		$T_j = 25^\circ\text{C}$	1.1	1.2	V
		$T_j = 125^\circ\text{C}$	0.8	0.9	V
r_F	at terminal	$T_j = 25^\circ\text{C}$	0.74	0.8	m Ω
		$T_j = 125^\circ\text{C}$	0.8	0.9	m Ω
E_{rr}	$I_F = 1200\text{ A}$ $T_j = 125^\circ\text{C}$	$V_R = 900\text{ V}$	144		mJ
		$V_R = 1200\text{ V}$	171		mJ
$R_{th(j-s)}$	per diode switch			0.029	K/W
$R_{th(j-r)}$	per diode switch			0.045	K/W
Driver					
V_s	supply voltage non stabilized	13	24	30	V
I_{SO}	bias current @ $V_s=24\text{V}$, $f_{sw} = 0$, $I_{AC} = 0$		330		mA
I_s	$k_1 = 55\text{ mA/kHz}$, $k_2 = 0.00035\text{ mA/A}^2$	= 330	$+ k_1 * f_{sw} + k_2 * I_{AC}^2$		mA
V_{IT+}	input threshold voltage (HIGH)	12.3			V
V_{IT-}	input threshold voltage (LOW)			4.6	V
R_{IN}	input resistance		10		k Ω
C_{IN}	input capacitance		1		nF
t_{pRESET}	error memory reset time		0.0122		ms
t_{TD}	top / bottom switch interlock time		3		μs
t_{jitter}	jitter clock time		125		ns
t_{SIS}	short pulse suppression time		0.625	0.7	μs
I_{TRIPSC}	over current trip level	2450	2500	2550	A _{PEAK}
T_{trip}	over temperature trip level	110	115	120	$^\circ\text{C}$
V_{DCtrip}	over voltage trip level,		not impl.		V
$t_{d(on)O}$	$V_{CC} = 1200\text{ V}$ $I_C = 1200\text{ A}$ $T_j = 25^\circ\text{C}$	input-output turn-on propagation time	1.4		μs
		input-output turn-off propagation time	1.4		μs
System					
$R_{th(r-a)}$	flow rate=8l/min, $T_{fluid}=50^\circ\text{C}$, water/ glycol ratio 50%:50%			0.0092	K/W
R_{CC+EE}	terminals to chip, $T_s = 25^\circ\text{C}$		0.13		m Ω
L_{CE}	commutation inductance		3		nH
C_{CHC}	per phase, AC-side		6.8		nF
$I_{CES} + I_{RD}$	$V_{GE} = 0\text{ V}$, $V_{CE} = 1700\text{ V}$, $T_j = 25^\circ\text{C}$		4.8		mA
M_{dc}	DC terminals, SI Units	6		8	Nm
M_{ac}	AC terminals, SI Units	13		15	Nm
w	SKiiP System w/o heat sink		3.1		kg
w_h	heat sink		6.2		kg

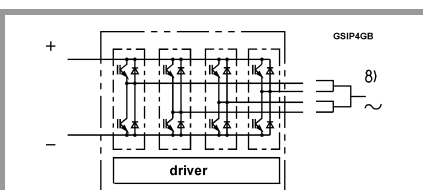

S43

Isolation coordination acc. to EN 50178 and IEC 61800-5-1

Maximum grid RMS voltage, line-to-line, star point grounded mains	690V+20%
Installation altitude for maximum grid RMS voltage, line-to-line, star point grounded mains	2000m
Maximum transient peak voltage between low voltage circuit and mains	1600V
Pollution degree acc. to IEC 60664-1 outside the moulded power section	2
Overvoltage cat. acc. to IEC 60664-1 for mains	III
Basic isolation	between heat sink and mains; between low voltage circuit and mains
Protection level acc. to IEC 60529	IP00

Environmental conditions acc.to IEC 60721

	Storage	Transportation	Operation stationary use at weather protected locations	Operating ground vehicle installations	Operating ship environment
Climatic conditions	1K2 ₍₁₎	2K2 ₍₁₎	3K3 ₍₁₎	5K1 ₍₁₎	---
Biological conditions	1B1	2B1	3B1	5B1	6B1
Chemically active substances (excluded: salt spray)	1C2	2C1	3C2	5C2	6C2
Mechanically active substances	1S1	2S1	3S1	5S1	6S1
Mechanical conditions	1M3	(4)	3M6 ₍₂₎	5M3 ₍₃₎	6M3
Contaminating fluids	---	---	---	5F1	---

(1) expanded temperature range: -40°C / +85°C. Please note: by operation near 85°C the life time of product is reduced.

(2) 3M7 possible, but due to the mechanic load capacity of external components like DC-Link capacitors limited to 3M6

(3) 5M3 without impact of foreign bodies, stones

(4) no declaration due to customer-specific packing

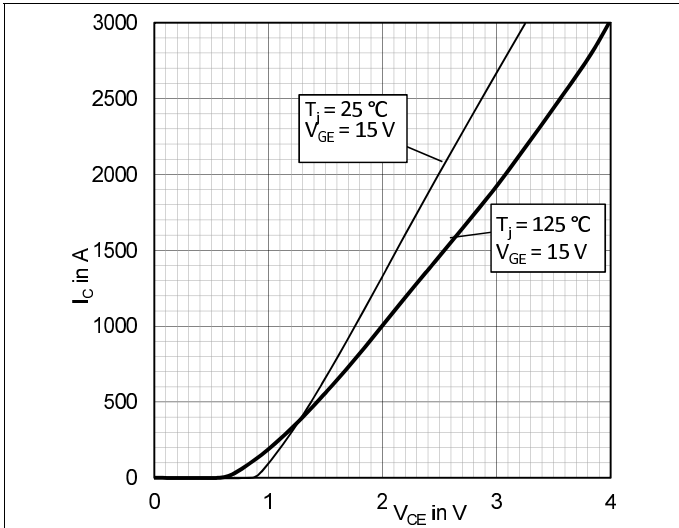

Fig. 1: Typical IGBT output characteristic

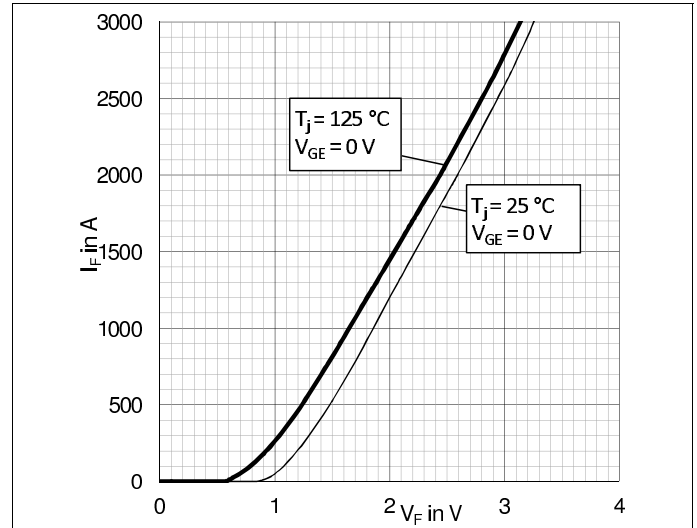

Fig. 2: Typical diode output characteristics

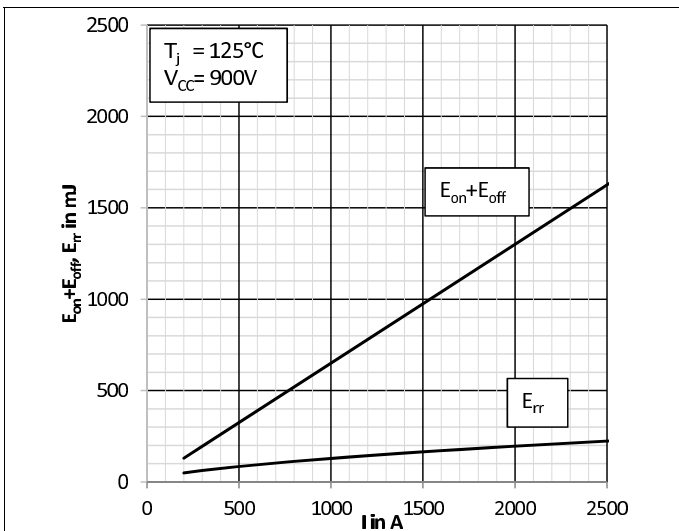

Fig. 3: Typical energy losses $E = f(I_c, V_{cc})$

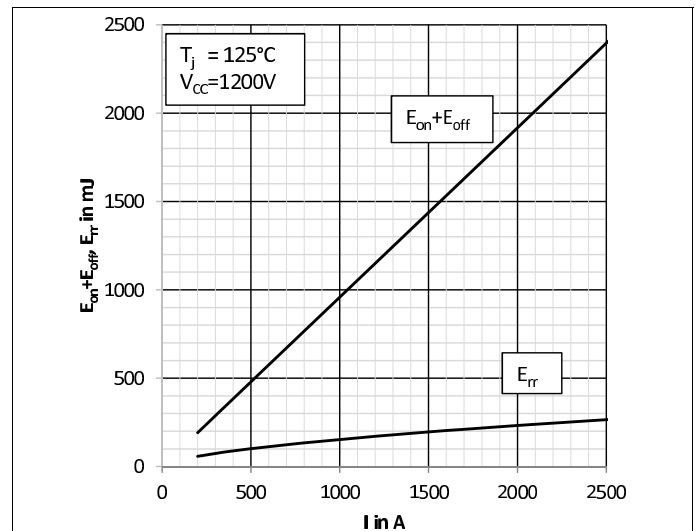

Fig. 4: Typical energy losses $E = f(I_c, V_{cc})$

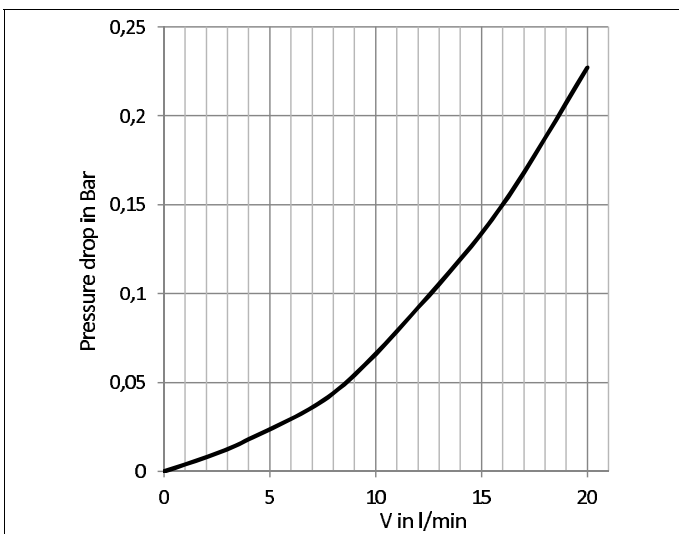

Fig. 5: Pressure drop Δp versus flow rate V

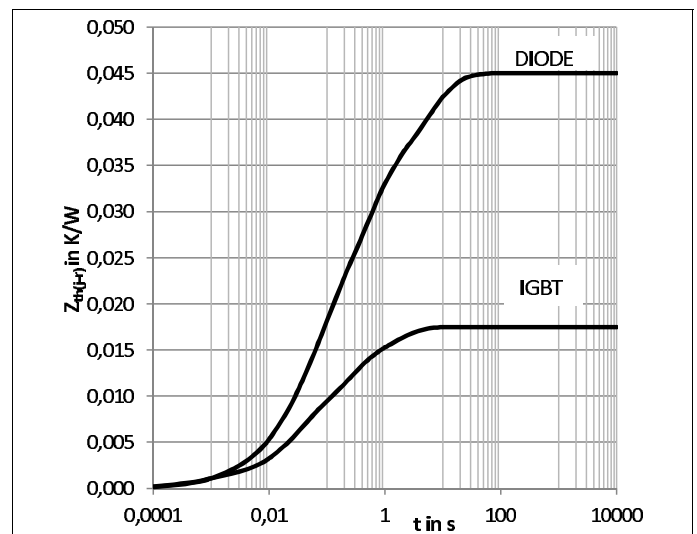

Fig. 6: Transient thermal impedance $Z_{th(j-r)}$

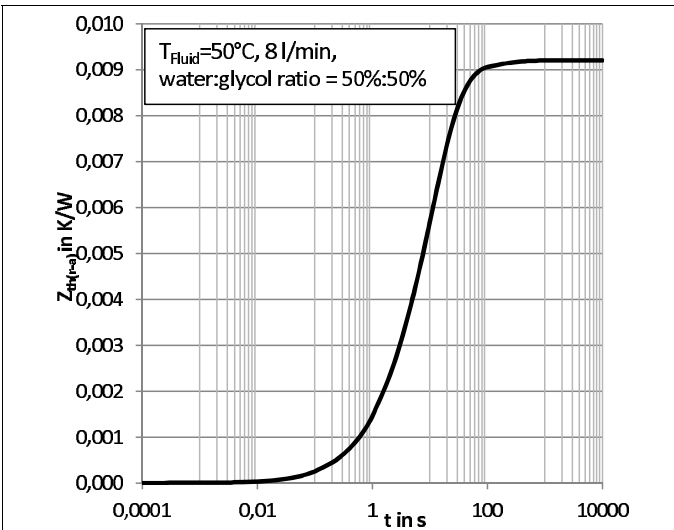

Fig. 7: Transient thermal impedance $Z_{th}(r-a)$

	$R_{th} [K/W]$					
	1	2	3	4	5	6
$Z_{th}(j-r) I$	0,0011	0,0059	0,0063	0,0021	0,0021	0,0000
$Z_{th}(j-r) D$	0,0011	0,0042	0,0129	0,0150	0,0094	0,0024
$Z_{th}(r-a)$	0,0002	0,0012	0,0042	0,0034	0,0002	0,0000

	$\tau [s]$					
	1	2	3	4	5	6
$Z_{th}(j-r) I$	0,0007	0,0268	0,2165	1,0453	2,2456	1,0000
$Z_{th}(j-r) D$	0,0013	0,0142	0,0676	0,4902	5,0713	14,977
$Z_{th}(r-a)$	0,1382	1,4254	8,3077	20,093	189,77	1,0000

Fig. 8: Coefficients of thermal impedances

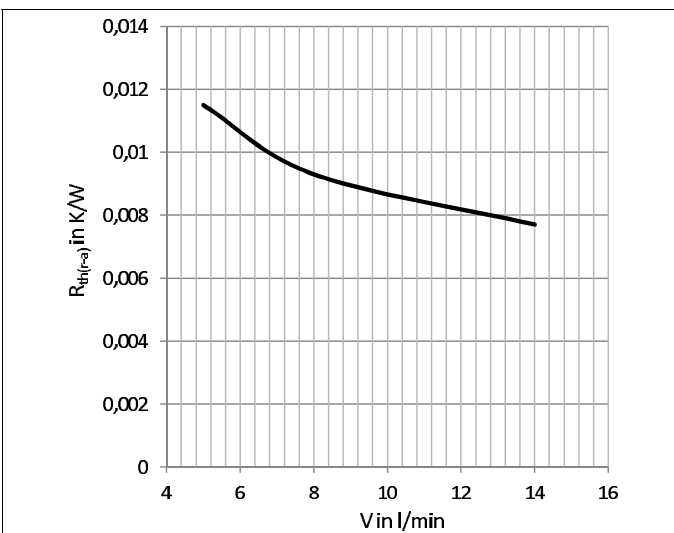
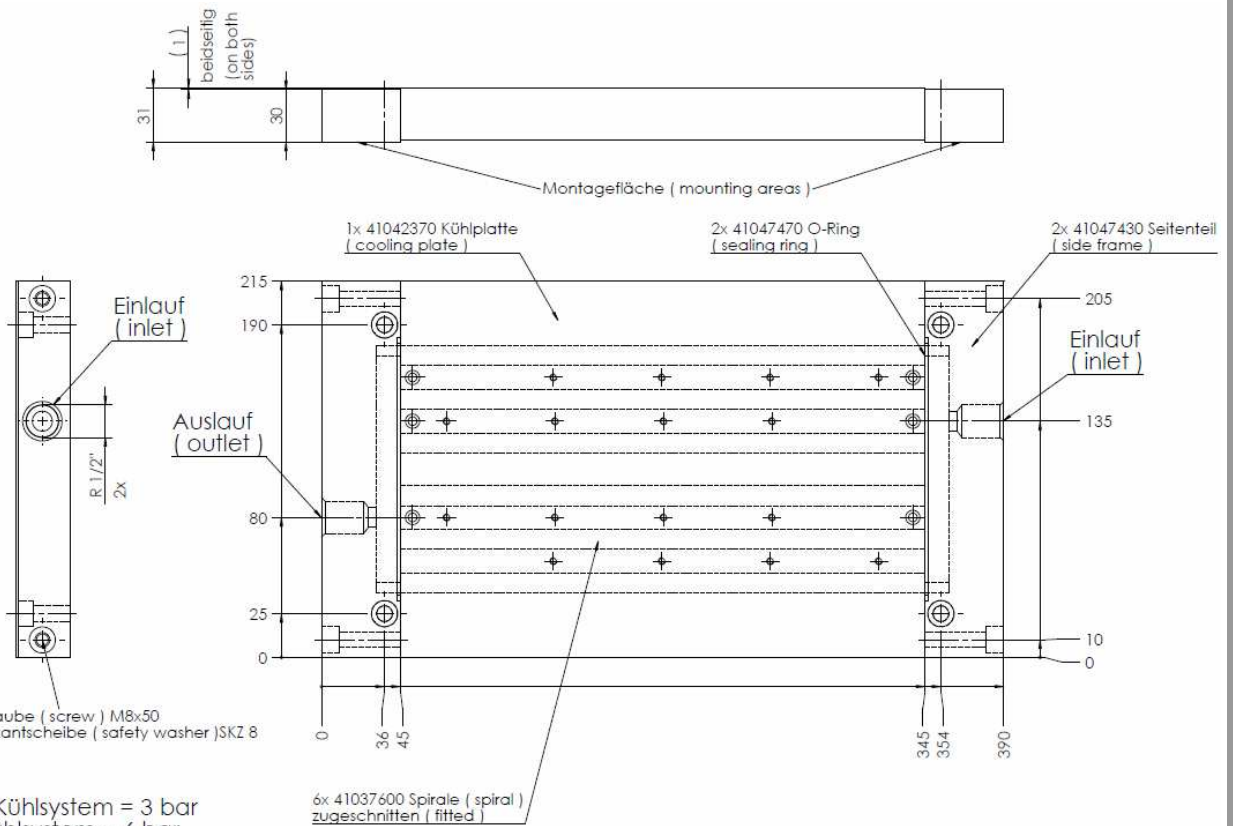

Fig. 9: Thermal resistance $R_{th}(r-a)$ versus flow rate V



Nenndruck/Kühlsystem = 3 bar
 Prüfdruck/Kühlsystem = 6 bar
 Kühlmedium mit Glykolanteil $\geq 10\%$

nominal pressure/cooling system = 3 bar
 test pressure/cooling system = 6 bar
 coolant with prestore $\geq 10\%$

Heat sink

SKiP 2013 GB172-4DW V3

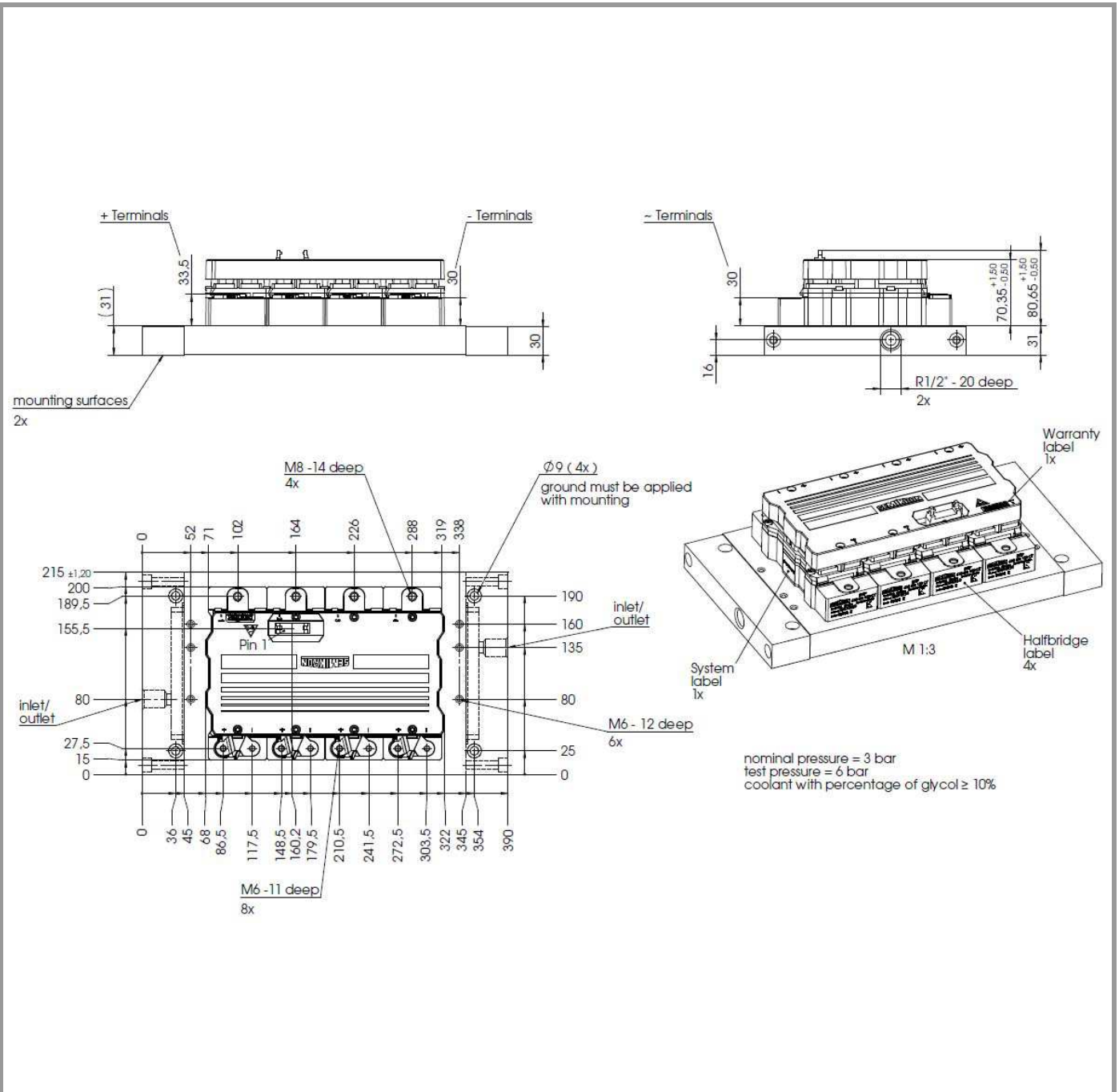

System

This is an electrostatic discharge sensitive device (ESDS), international standard IEC 60747-1, Chapter IX

* The specifications of our components may not be considered as an assurance of component characteristics. Components have to be tested for the respective application. Adjustments may be necessary. The use of SEMIKRON products in life support appliances and systems is subject to prior specification and written approval by SEMIKRON. We therefore strongly recommend prior consultation of our staff.