

$V_{DRM}$	=	8500 V
$I_{T(AV)M}$	=	4240 A
$I_{T(RMS)}$	=	6660 A
$I_{TSM}$	=	$90 \cdot 10^3$ A
$V_{T0}$	=	1.10 V
$r_T$	=	0.16 m $\Omega$

# Phase Control Thyristor

## 5STP 45Y8500

Doc. No. 5SYA1079-02 Oct. 16

- Patented free-floating silicon technology
- Low on-state and switching losses
- Designed for traction, energy and industrial applications
- Optimum power handling capability
- Interdigitated amplifying gate
- Custom irradiation variant available on request

### Blocking

Maximum rated values <sup>1)</sup>

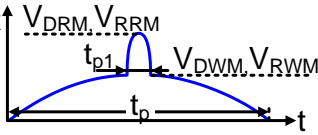
Parameter	Symbol	Conditions	5STP 45Y8500	Unit
Max. surge peak forward and reverse blocking voltage	$V_{DSM}$ , $V_{RSM}$	$t_p = 10$ ms, $f = 5$ Hz $T_{vj} = 5 \dots 110$ °C, Note 1	8500	V
Max repetitive peak forward and reverse blocking voltage	$V_{DRM}$ , $V_{RRM}$	$f = 50$ Hz, $t_p = 10$ ms, $t_{p1} = 250$ $\mu$ s, $T_{vj} = 5 \dots 110$ °C, Note 1, Note 2	8500	V
Max crest working forward and reverse voltages	$V_{DWM}$ , $V_{RWM}$		5670	V
Critical rate of rise of commutating voltage	$dv/dt_{crit}$	Exp. to $0.67 \cdot V_{DRM}$ , $T_{vj} = 110$ °C	2000	V/ $\mu$ s

Characteristic values

Parameter	Symbol	Conditions	min	typ	max	Unit
Forward leakage current	$I_{DRM}$	$V_{DRM}$ , $T_{vj} = 110$ °C			2000	mA
Reverse leakage current	$I_{RRM}$	$V_{RRM}$ , $T_{vj} = 110$ °C			2000	mA

Note 1: Voltage de-rating factor of 0.11% per °C is applicable for  $T_{vj}$  below +25 °C.

Note 2: Recommended minimum ratio of  $V_{DRM} / V_{DWM}$  or  $V_{RRM} / V_{RWM} = 2$ . See App. Note 5SYA 2051.

### Mechanical data

Maximum rated values <sup>1)</sup>

Parameter	Symbol	Conditions	min	typ	max	Unit
Mounting force	$F_M$		170	190	210	kN
Acceleration	$a$	Device unclamped			50	m/s <sup>2</sup>
Acceleration	$a$	Device clamped			100	m/s <sup>2</sup>

Characteristic values

Parameter	Symbol	Conditions	min	typ	max	Unit
Weight	$m$				5.14	kg
Housing thickness	$H$	$F_M = 190$ kN, $T_a = 25$ °C	35.0		35.4	mm
Surface creepage distance	$D_s$		56			mm
Air strike distance	$D_a$		22			mm

1) Maximum rated values indicate limits beyond which damage to the device may occur

ABB Switzerland Ltd, Semiconductors reserves the right to change specifications without notice.



## On-state

### Maximum rated values <sup>1)</sup>

Parameter	Symbol	Conditions	min	typ	max	Unit
Average on-state current	$I_{T(AV)M}$	Half sine wave, $T_c = 70\text{ °C}$			4240	A
RMS on-state current	$I_{T(RMS)}$				6660	A
Peak non-repetitive surge current	$I_{TSM}$	$t_p = 10\text{ ms}$ , $T_{vj} = 110\text{ °C}$ , sine half wave,			$90 \cdot 10^3$	A
Limiting load integral	$I^2t$	$V_D = V_R = 0\text{ V}$ , after surge			$40.5 \cdot 10^6$	A <sup>2</sup> s
Peak non-repetitive surge current	$I_{TSM}$	$t_p = 10\text{ ms}$ , $T_{vj} = 110\text{ °C}$ , sine half wave,				A
Limiting load integral	$I^2t$	$V_R = 0.6 \cdot V_{RRM}$ , after surge				A <sup>2</sup> s

### Characteristic values

Parameter	Symbol	Conditions	min	typ	max	Unit
On-state voltage	$V_T$	$I_T = 5000\text{ A}$ , $T_{vj} = 110\text{ °C}$		1.81	1.90	V
Threshold voltage	$V_{(T0)}$	$I_T = 2000\text{ A} - 6000\text{ A}$ , $T_{vj} = 110\text{ °C}$		1.06	1.10	V
Slope resistance	$r_T$				0.15	0.16
Holding current	$I_H$	$T_{vj} = 25\text{ °C}$			150	mA
		$T_{vj} = 110\text{ °C}$			100	mA
Latching current	$I_L$	$T_{vj} = 25\text{ °C}$			1500	mA
		$T_{vj} = 110\text{ °C}$			1000	mA

## Switching

### Maximum rated values <sup>1)</sup>

Parameter	Symbol	Conditions	min	typ	max	Unit
Critical rate of rise of on-state current	$di/dt_{crit}$	$T_{vj} = 110\text{ °C}$ , $I_{TRM} = 3000\text{ A}$ , $V_D \leq 0.67 \cdot V_{DRM}$ , $I_{FG} = 5\text{ A}$ , $t_r = 0.5\text{ }\mu\text{s}$			200	A/ $\mu\text{s}$
			Cont. $f = 50\text{ Hz}$			1000
Circuit-commutated turn-off time	$t_q$	$T_{vj} = 110\text{ °C}$ , $I_{TRM} = 3000\text{ A}$ , $V_R = 200\text{ V}$ , $di_r/dt = -1.5\text{ A}/\mu\text{s}$ , $V_D \leq 0.67 \cdot V_{DRM}$ , $dV_D/dt = 20\text{ V}/\mu\text{s}$			950	$\mu\text{s}$

### Characteristic values

Parameter	Symbol	Conditions	min	typ	max	Unit
Reverse recovery charge	$Q_{rr}$	$T_{vj} = 110\text{ °C}$ , $I_{TRM} = 3000\text{ A}$ , $V_R = 200\text{ V}$ , $di_r/dt = -1.5\text{ A}/\mu\text{s}$	6500		9900	$\mu\text{As}$
Reverse recovery current	$I_{RM}$				140	A
Gate turn-on delay time	$t_{gd}$	$T_{vj} = 25\text{ °C}$ , $V_D = 0.4 \cdot V_{RM}$ , $I_{FG} = 5\text{ A}$ , $t_r = 0.5\text{ }\mu\text{s}$	1.5		3.5	$\mu\text{s}$

## Triggering

Maximum rated values <sup>1)</sup>

Parameter	Symbol	Conditions	min	typ	max	Unit
Peak forward gate voltage	V <sub>FGM</sub>				12	V
Peak forward gate current	I <sub>FGM</sub>				10	A
Peak reverse gate voltage	V <sub>RGM</sub>				10	V
Average gate power loss	P <sub>G(AV)</sub>		see Fig. 6			W

Characteristic values

Parameter	Symbol	Conditions	min	typ	max	Unit
Gate-trigger voltage	V <sub>GT</sub>	T <sub>vj</sub> = 25 °C			2.6	V
Gate-trigger current	I <sub>GT</sub>	T <sub>vj</sub> = 25 °C			400	mA
Gate non-trigger voltage	V <sub>GD</sub>	V <sub>D</sub> = 0.4 · V <sub>DRM</sub> , T <sub>vjmax</sub> = 110 °C dv/dt = 2000 V/μs			0.3	V
Gate non-trigger current	I <sub>GD</sub>				10	mA

## Thermal

Maximum rated values <sup>1)</sup>

Parameter	Symbol	Conditions	min	typ	max	Unit
Operating junction temperature range	T <sub>vj</sub>		5		110	°C
Storage temperature range	T <sub>stg</sub>		-40		140	°C

Characteristic values

Parameter	Symbol	Conditions	min	typ	max	Unit
Thermal resistance junction to case	R <sub>th(j-c)</sub>	Double-side cooled F <sub>m</sub> = 170... 210 kN			3	K/kW
	R <sub>th(j-c)A</sub>	Anode-side cooled F <sub>m</sub> = 170... 210 kN			6	K/kW
	R <sub>th(j-c)C</sub>	Cathode-side cooled F <sub>m</sub> = 170... 210 kN			6	K/kW
Thermal resistance case to heatsink	R <sub>th(c-h)</sub>	Double-side cooled F <sub>m</sub> = 170... 210 kN			0.6	K/kW
	R <sub>th(c-h)</sub>	Single-side cooled F <sub>m</sub> = 170... 210 kN			1.2	K/kW

Analytical function for transient thermal impedance:

$$Z_{th(j-c)}(t) = \sum_{i=1}^n R_i (1 - e^{-t/\tau_i})$$

i	1	2	3	4
R <sub>i</sub> (K/kW)	2.005	0.602	0.251	0.141
τ <sub>i</sub> (s)	0.939	0.146	0.024	0.006

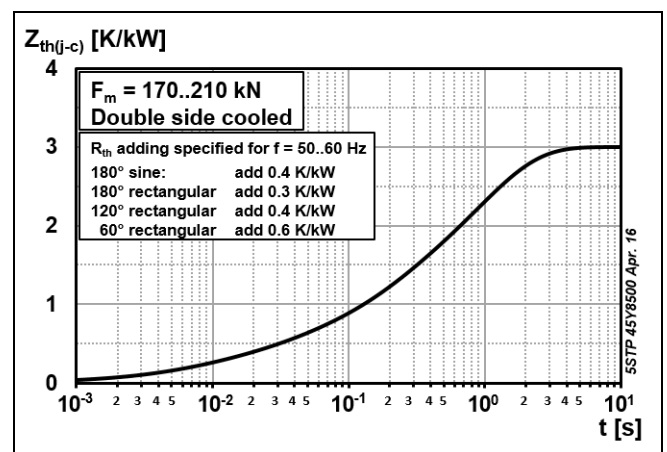

Fig. 1 Transient thermal impedance (junction-to-case) vs. time

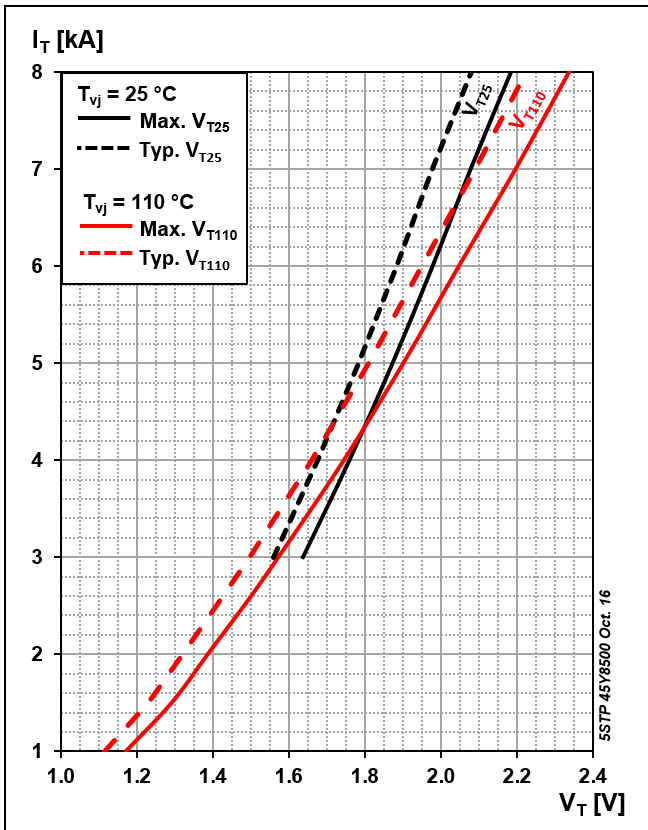

Fig. 2 On-state voltage characteristics

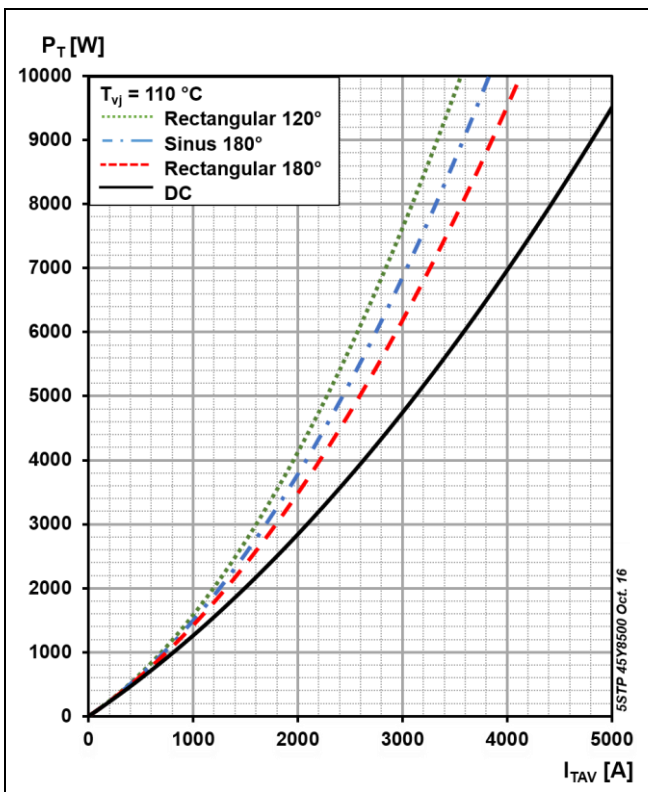

Fig. 3 On-state power dissipation vs. mean on-state current, turn-on losses excluded

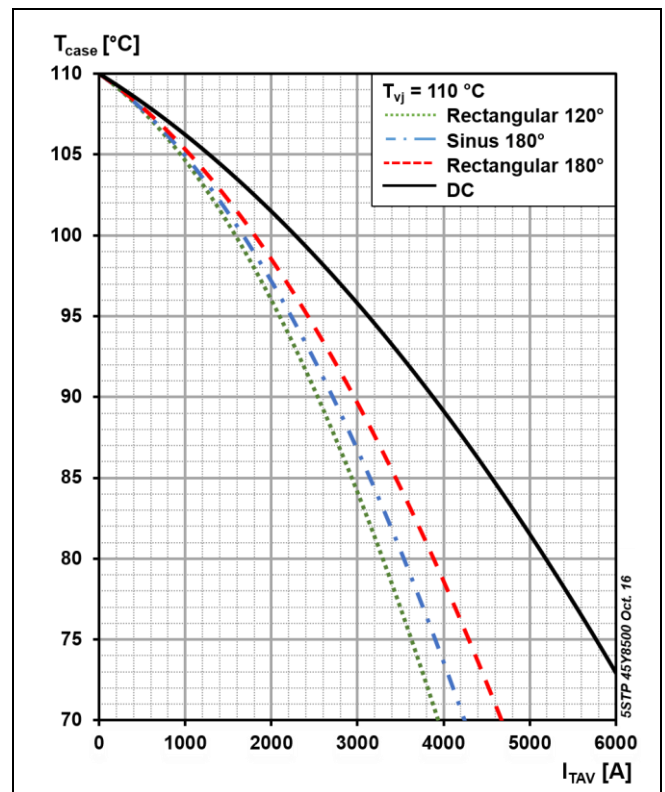

Fig. 4 Max. permissible case temperature vs. mean on-state current, switching losses ignored

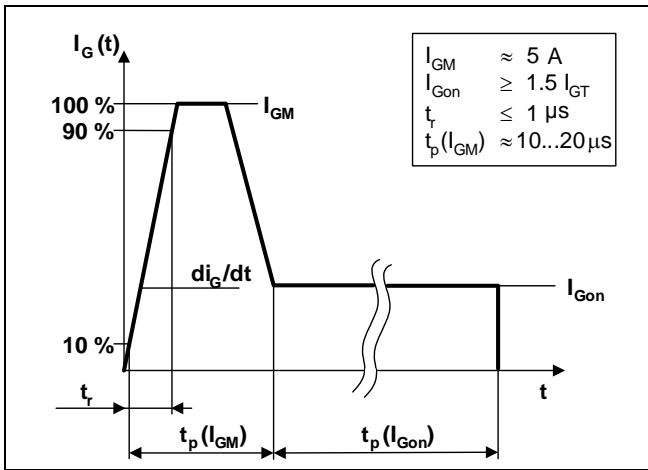

Fig. 5 Recommended gate current waveform

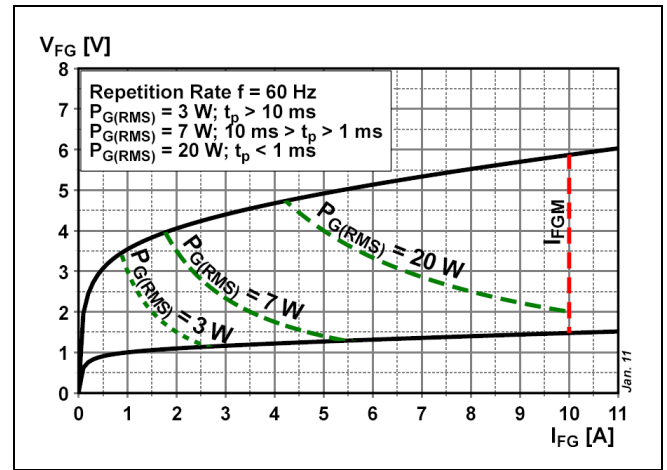

Fig. 6 Max. peak gate power loss

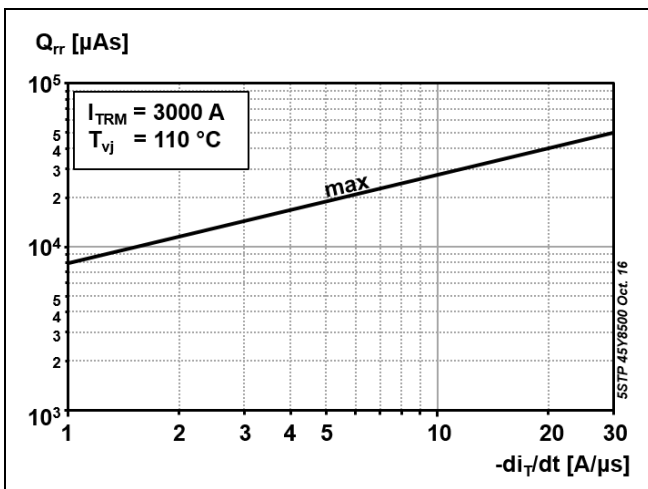

Fig. 7 Reverse recovery charge vs. decay rate of on-state current

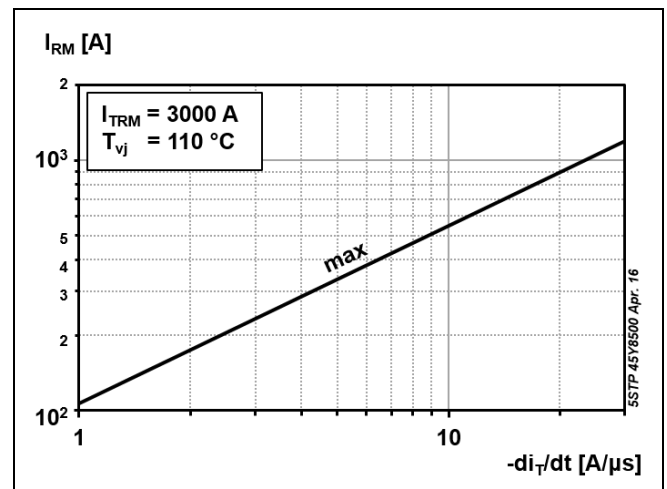

Fig. 8 Peak reverse recovery current vs. decay rate of on-state current

# Power losses

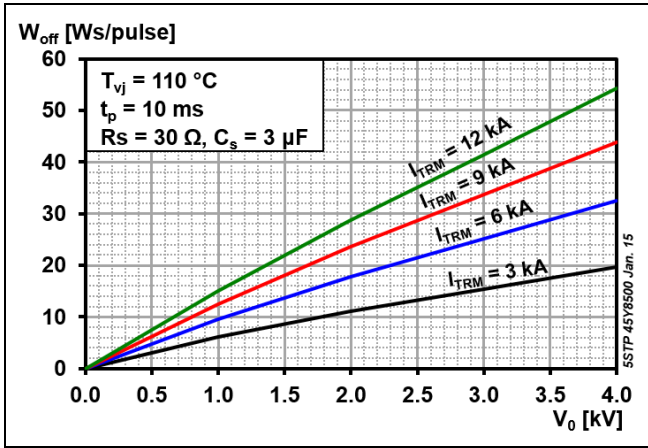

Fig. 9 Turn-off energy, half sinusoidal waves

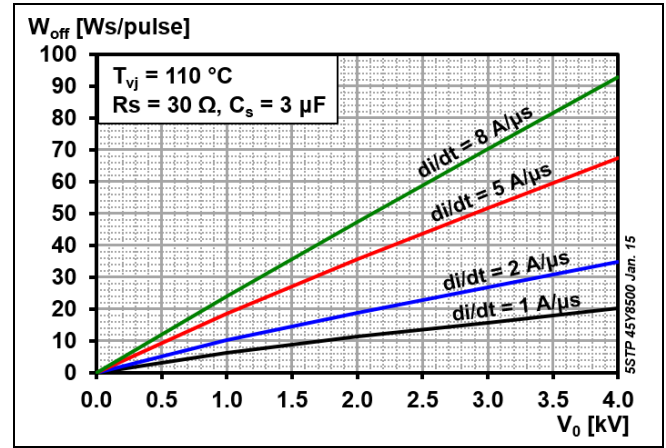

Fig. 10 Turn-off energy, rectangular waves

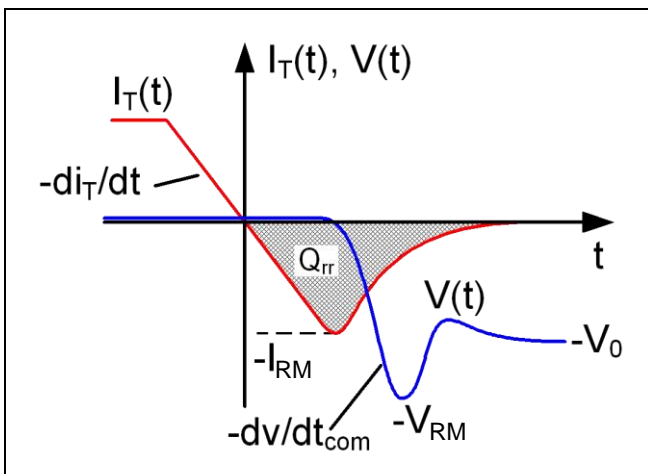

Fig. 11 Current and voltage waveforms at turn-off

**Total power loss for repetitive waveforms:**

$$P_{TOT} = P_T + W_{on} \cdot f + W_{off} \cdot f$$

where

$$P_T = \frac{1}{T} \int_0^T I_T \cdot V_T(I_T) dt$$

Fig. 12 Relationships for power loss

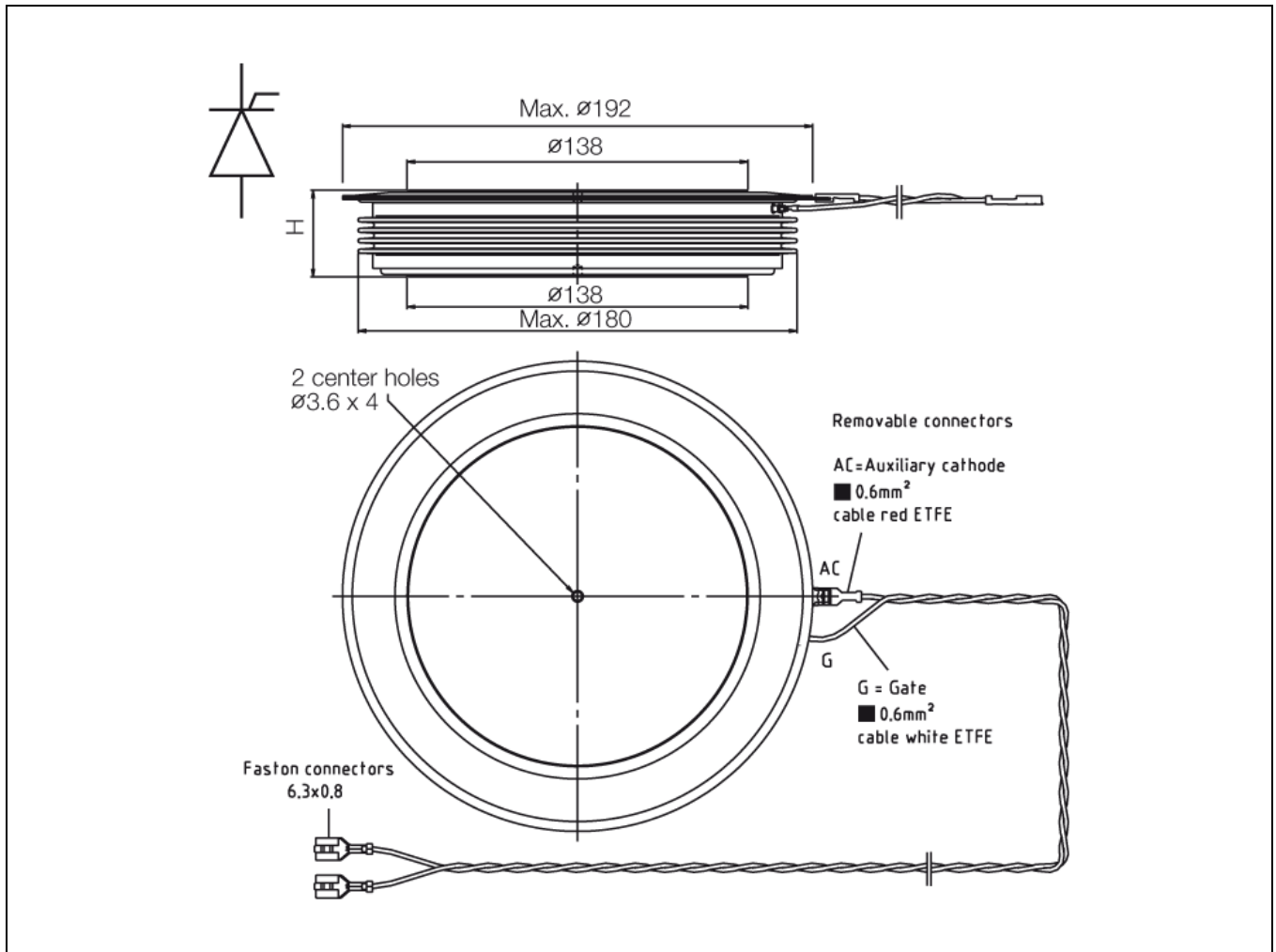

Fig. 13 Device Outline Drawing

### Related documents:

5SYA 2020	Design of RC-Snubber for Phase Control Applications
5SYA 2049	Voltage definitions for phase control thyristors and diodes
5SYA 2051	Voltage ratings of high power semiconductors
5SYA 2034	Gate-Drive Recommendations for PCT's
5SYA 2036	Recommendations regarding mechanical clamping of Press Pack High Power Semiconductors
5SYA 2102	Surge currents for Phase Control Thyristors
5SZK 9104	Specification of environmental class for pressure contact diodes, PCTs and GTO, STORAGE
5SZK 9105	Specification of environmental class for pressure contact diodes, PCTs and GTO, TRANSPORTATION
5SZK 9115	Specification of environmental class for presspack Diodes, PCTs and GTOs, OPERATION (Industry)
5SZK 9116	Specification of environmental class for presspack Diodes, PCTs and GTOs, OPERATION (Traction)

Please refer to <http://www.abb.com/semiconductors> for current version of documents.

**ABB Switzerland Ltd, Semiconductors reserves the right to change specifications without notice.**



**ABB Switzerland Ltd**  
**Semiconductors**  
 Fabrikstrasse 3  
 CH-5600 Lenzburg, Switzerland

Doc. No. 5SYA1079-02 Oct. 16

Telephone +41 (0)58 586 1419  
 Fax +41 (0)58 586 1306  
 Email [abbsem@ch.abb.com](mailto:abbsem@ch.abb.com)  
 Internet [www.abb.com/semiconductors](http://www.abb.com/semiconductors)