

Single Phase Rectifier Bridge with Fast Recovery Epitaxial Diodes (FRED) in ECO-PAC 2

$I_{dAV} = 100 \text{ A}$
 $V_{RRM} = 600 \text{ V}$
 $t_{rr} = 35 \text{ ns}$

Preliminary data sheet

| V_{RSM} V | V_{RRM} V | Typ |
|----------------|----------------|---------------|
| 600 | 600 | VBE 100-06NO7 |

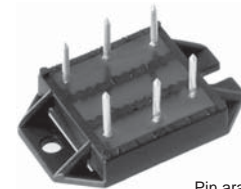
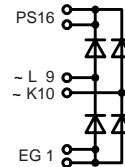

Pin arrangement see outlines

| Symbol | Conditions | Maximum Ratings | |
|-----------------|--|------------------------------------|-----------------------|
| $I_{dAV}^{①}$ | $T_C = 85^\circ\text{C}$, module | 100 | A |
| I_{dAVM} | | 100 | A |
| I_{FSM} | $T_{VJ} = 45^\circ\text{C}$ $V_R = 0$ | $t = 10 \text{ ms}$ (50 Hz), sine | 600 A |
| | | $t = 8.3 \text{ ms}$ (60 Hz), sine | 640 A |
| | $T_{VJ} = T_{VJM}$ $V_R = 0$ | $t = 10 \text{ ms}$ (50 Hz), sine | 520 A |
| | | $t = 8.3 \text{ ms}$ (60 Hz), sine | 555 A |
| I^2t | $T_{VJ} = 45^\circ\text{C}$ $V_R = 0$ | $t = 10 \text{ ms}$ (50 Hz), sine | 1800 A ² s |
| | | $t = 8.3 \text{ ms}$ (60 Hz), sine | 1720 A ² s |
| | $T_{VJ} = T_{VJM}$ $V_R = 0$ | $t = 10 \text{ ms}$ (50 Hz), sine | 1350 A ² s |
| | | $t = 8.3 \text{ ms}$ (60 Hz), sine | 1295 A ² s |
| T_{VJ} | | -40...+150 | $^\circ\text{C}$ |
| T_{VJM} | | 150 | $^\circ\text{C}$ |
| T_{stg} | | -40...+125 | $^\circ\text{C}$ |
| V_{ISOL} | 50/60 Hz, RMS | $t = 1 \text{ min}$ | 3000 V~ |
| | $I_{ISOL} \leq 1 \text{ mA}$ | $t = 1 \text{ s}$ | 3600 V~ |
| M_d Weight | Mounting torque (M4) | 1.5-2/14-18 | Nm/lb.in. |
| | typ. | 24 | g |

Features

- Package with DCB ceramic base plate in low profile
- Isolation voltage 3000 V~
- Planar passivated chips
- Low forward voltage drop
- Leads suitable for PC board soldering

Applications

- Supplies for DC power equipment
- Input and output rectifiers for high frequency
- Battery DC power supplies
- Field supply for DC motors

Advantages

- Space and weight savings
- Improved temperature and power cycling capability
- Small and light weight
- Low noise switching

| Symbol | Conditions | Characteristic Values | |
|------------|--|-----------------------|------------------|
| | | typ. | max. |
| I_R | $V_R = V_{RRM}$ $T_{VJ} = 25^\circ\text{C}$ | | 0.1 mA |
| | $V_R = V_{RRM}$ $T_{VJ} = T_{VJM}$ | | 2.5 mA |
| V_F | $I_F = 60 \text{ A}$ $T_{VJ} = 25^\circ\text{C}$ | | 2.04 V |
| V_{T0} | for power-loss calculations only | | 1.09 V |
| r_T | | | 4.3 m Ω |
| R_{thJC} | per diode; DC current | | 0.8 K/W |
| R_{thCH} | per diode; DC current, typ. | | 0.2 K/W |
| I_{RM} | $I_F = 130 \text{ A}$, $-di/dt = 100 \text{ A}/\mu\text{s}$ $V_R = 100 \text{ V}$, $T_{VJ} = 100^\circ\text{C}$ | | 6.8 A |
| t_{rr} | $I_F = 1 \text{ A}$; $-di/dt = 300 \text{ A}/\mu\text{s}$; $V_R = 30 \text{ V}$, $T_{VJ} = 25^\circ\text{C}$ | 35 | ns |
| a | Max. allowable acceleration | 50 | m/s ² |
| d_s | creeping distance on surface (pin to heatsink) | 11.2 | mm |
| d_A | strike distance in air (pin to heatsink) | 9.7 | mm |

Data according to IEC 60747 refer to a single diode unless otherwise stated

① for resistive load at bridge output.

IXYS reserves the right to change limits, test conditions and dimensions.

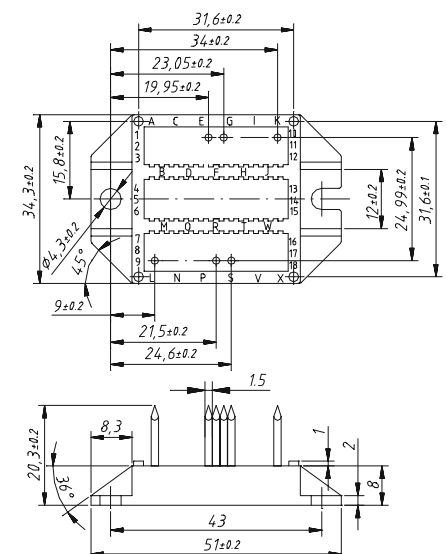
Dimensions in mm (1 mm = 0.0394")

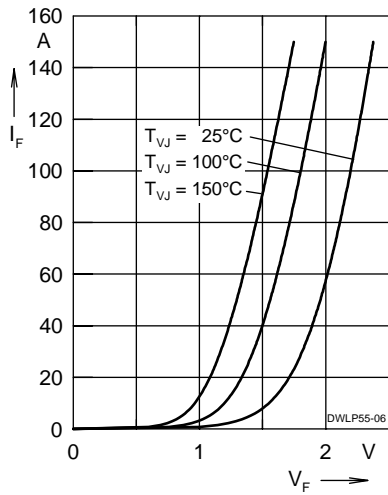

Fig. 1 Forward current I_F versus V_F

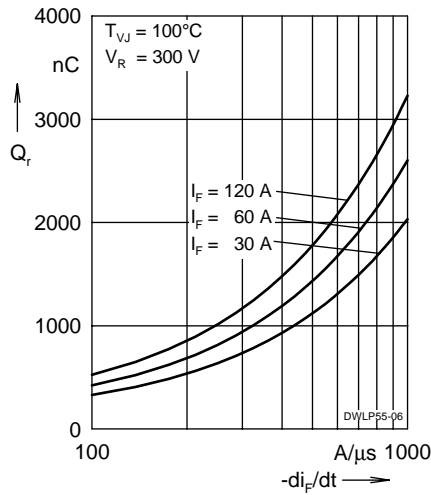

Fig. 2 Reverse recovery charge Q_r versus $-di_F/dt$

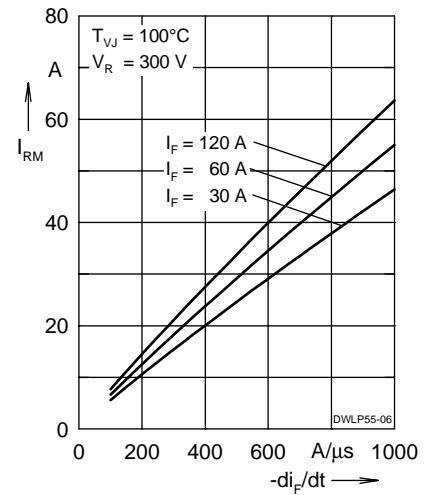

Fig. 3 Peak reverse current I_{RM} versus $-di_F/dt$

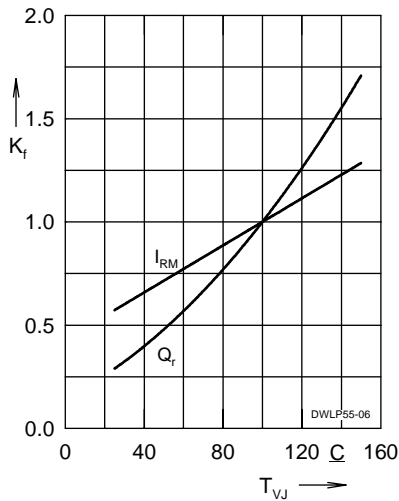

Fig. 4 Dynamic parameters Q_r , I_{RM} versus T_{VJ}

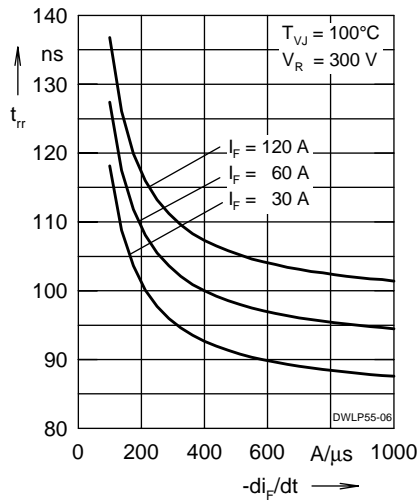

Fig. 5 Recovery time t_{rr} versus $-di_F/dt$

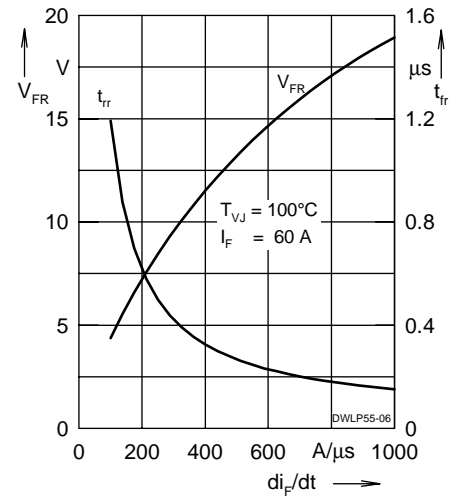

Fig. 6 Peak forward voltage V_{FR} and t_{tr} versus di_F/dt

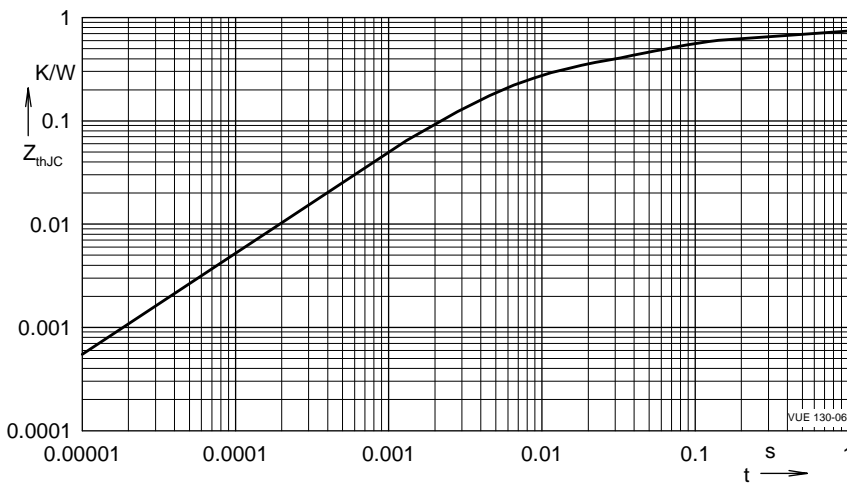

Fig. 7 Typical transient thermal resistance junction to case

NOTE: Fig. 2 to Fig. 6 shows typical values

IXYS reserves the right to change limits, test conditions and dimensions.