

Standard Rectifier Module

3~ Rectifier	
V_{RRM}	= 1600 V
I_{DAV}	= 105 A
I_{FSM}	= 750 A

3~ Rectifier Bridge

Part number

VUO98-16NO7

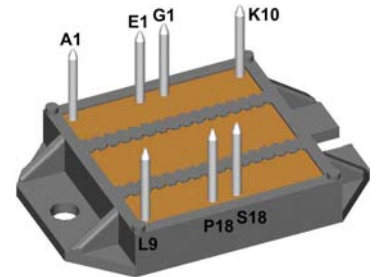

E72873

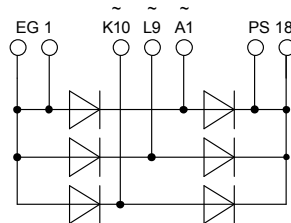

Features / Advantages:

- Package with DCB ceramic
- Improved temperature and power cycling
- Planar passivated chips
- Very low forward voltage drop
- Very low leakage current

Applications:

- Diode for main rectification
- For three phase bridge configurations
- Supplies for DC power equipment
- Input rectifiers for PWM inverter
- Battery DC power supplies
- Field supply for DC motors

Package: ECO-PAC2

- Industry standard outline
- RoHS compliant
- Soldering pins for PCB mounting
- Height: 9 mm
- Base plate: DCB ceramic
- Reduced weight
- Advanced power cycling

Rectifier				Ratings		
Symbol	Definition	Conditions	min.	typ.	max.	Unit
V_{RSM}	max. non-repetitive reverse blocking voltage	$T_{VJ} = 25^{\circ}\text{C}$			1700	V
V_{RRM}	max. repetitive reverse blocking voltage	$T_{VJ} = 25^{\circ}\text{C}$			1600	V
I_R	reverse current	$V_R = 1600\text{ V}$	$T_{VJ} = 25^{\circ}\text{C}$		100	μA
		$V_R = 1600\text{ V}$	$T_{VJ} = 150^{\circ}\text{C}$		1.5	mA
V_F	forward voltage drop	$I_F = 40\text{ A}$	$T_{VJ} = 25^{\circ}\text{C}$		1.14	V
		$I_F = 120\text{ A}$			1.48	V
		$I_F = 40\text{ A}$	$T_{VJ} = 125^{\circ}\text{C}$		1.06	V
		$I_F = 120\text{ A}$			1.51	V
I_{DAV}	bridge output current	$T_C = 115^{\circ}\text{C}$ rectangular $d = \frac{1}{3}$	$T_{VJ} = 150^{\circ}\text{C}$		105	A
V_{FO}	threshold voltage	} for power loss calculation only	$T_{VJ} = 150^{\circ}\text{C}$		0.81	V
r_F	slope resistance				5.9	m Ω
R_{thJC}	thermal resistance junction to case				0.7	K/W
R_{thCH}	thermal resistance case to heatsink			0.3		K/W
P_{tot}	total power dissipation		$T_C = 25^{\circ}\text{C}$		175	W
I_{FSM}	max. forward surge current	$t = 10\text{ ms}; (50\text{ Hz}), \text{ sine}$	$T_{VJ} = 45^{\circ}\text{C}$		750	A
		$t = 8,3\text{ ms}; (60\text{ Hz}), \text{ sine}$	$V_R = 0\text{ V}$		810	A
		$t = 10\text{ ms}; (50\text{ Hz}), \text{ sine}$	$T_{VJ} = 150^{\circ}\text{C}$		640	A
		$t = 8,3\text{ ms}; (60\text{ Hz}), \text{ sine}$	$V_R = 0\text{ V}$		690	A
I^2t	value for fusing	$t = 10\text{ ms}; (50\text{ Hz}), \text{ sine}$	$T_{VJ} = 45^{\circ}\text{C}$		2.82	kA ² s
		$t = 8,3\text{ ms}; (60\text{ Hz}), \text{ sine}$	$V_R = 0\text{ V}$		2.73	kA ² s
		$t = 10\text{ ms}; (50\text{ Hz}), \text{ sine}$	$T_{VJ} = 150^{\circ}\text{C}$		2.05	kA ² s
		$t = 8,3\text{ ms}; (60\text{ Hz}), \text{ sine}$	$V_R = 0\text{ V}$		1.98	kA ² s
C_J	junction capacitance	$V_R = 400\text{ V}; f = 1\text{ MHz}$	$T_{VJ} = 25^{\circ}\text{C}$		11	pF

Package ECO-PAC2		Ratings				
Symbol	Definition	Conditions	min.	typ.	max.	Unit
I_{RMS}	RMS current	per terminal			100	A
T_{stg}	storage temperature		-40		125	°C
T_{VJ}	virtual junction temperature		-40		150	°C
Weight				24		g
M_D	mounting torque		1.5		2	Nm
$d_{Spp/App}$	creepage distance on surface striking distance through air	terminal to terminal	6.0			mm
$d_{Spb/Apb}$		terminal to backside	10.0			mm
V_{ISOL}	isolation voltage	t = 1 second	3000			V
		t = 1 minute	2500			V

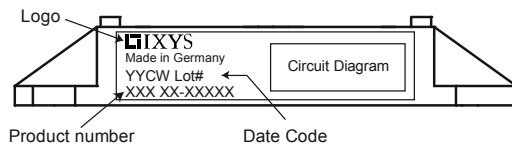

Ordering	Part Number	Marking on Product	Delivery Mode	Quantity	Code No.
Standard	VUO98-16NO7	VUO98-16NO7	Box	25	494526

Equivalent Circuits for Simulation

* on die level

$T_{VJ} = 150\text{ °C}$

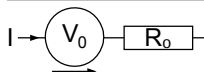

Rectifier

$V_{0\ max}$	threshold voltage	0.81	V
$R_{0\ max}$	slope resistance *	4.6	mΩ

Outlines ECO-PAC2

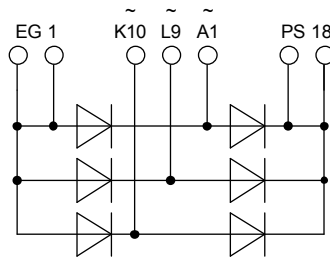
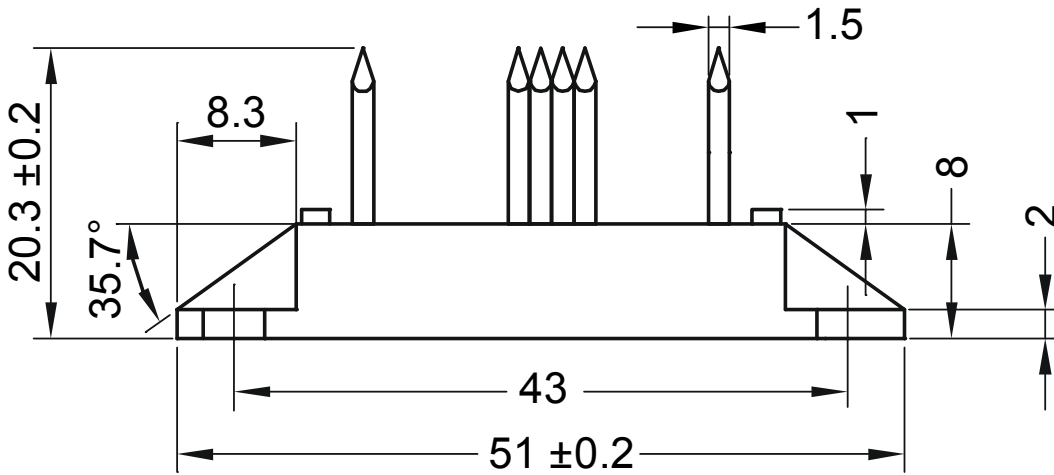
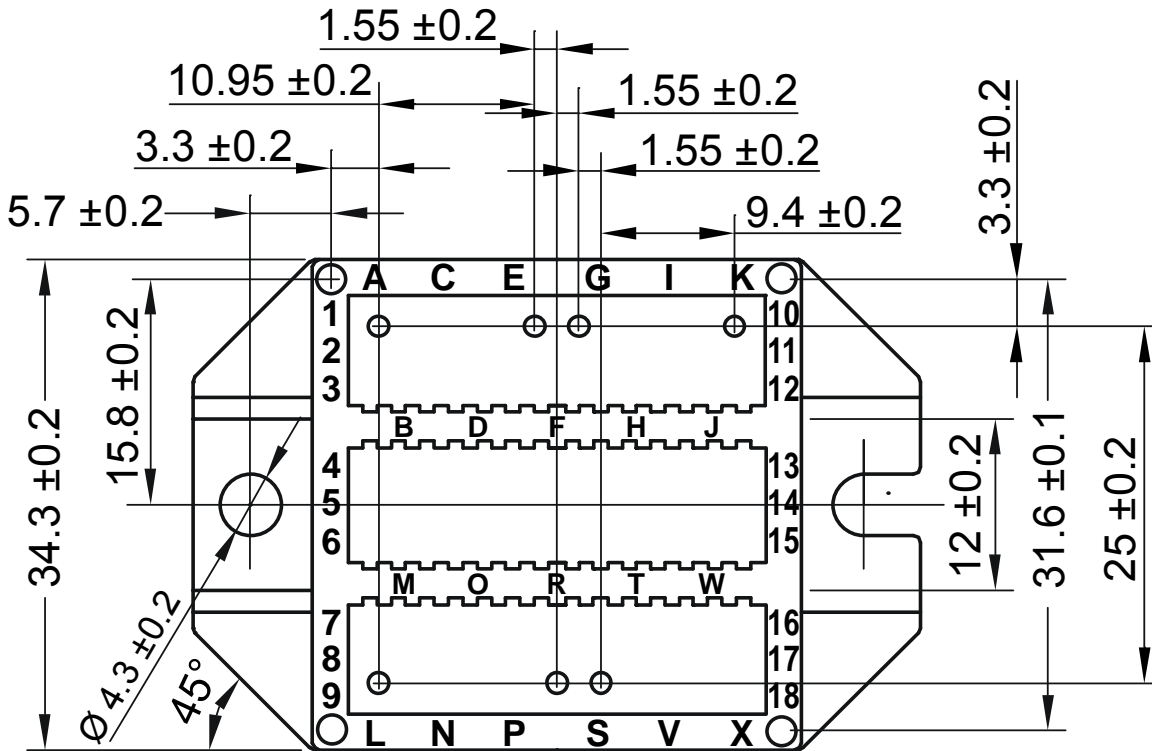

Rectifier

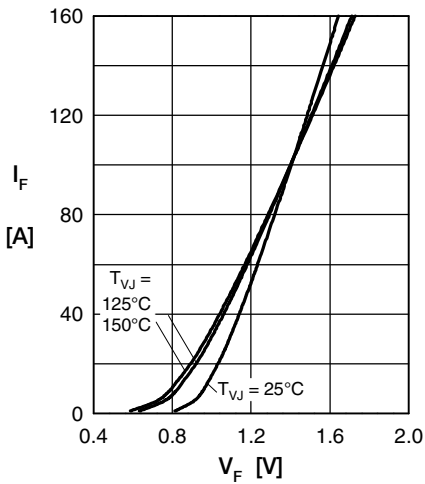

Fig. 1 Forward current versus voltage drop per diode

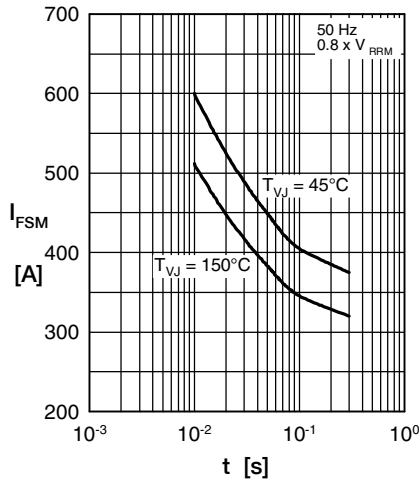

Fig. 2 Surge overload current

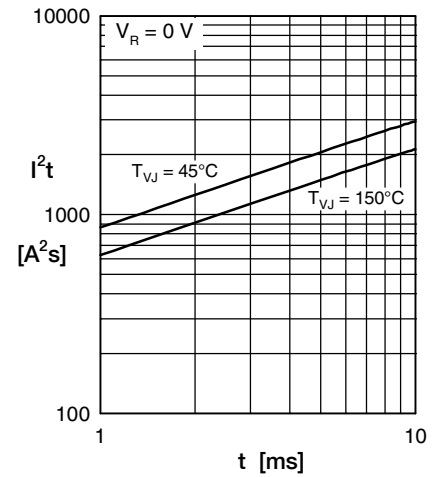

Fig. 3 I^2t versus time per diode

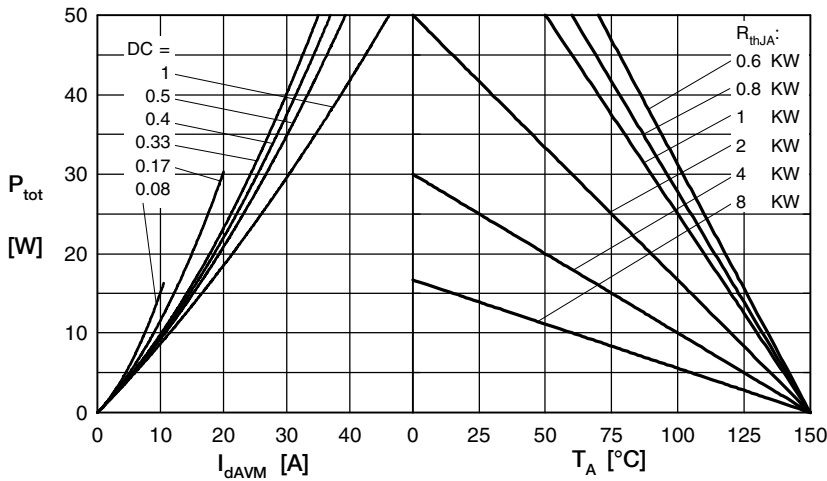

Fig. 4 Power dissipation vs. direct output current & ambient temperature

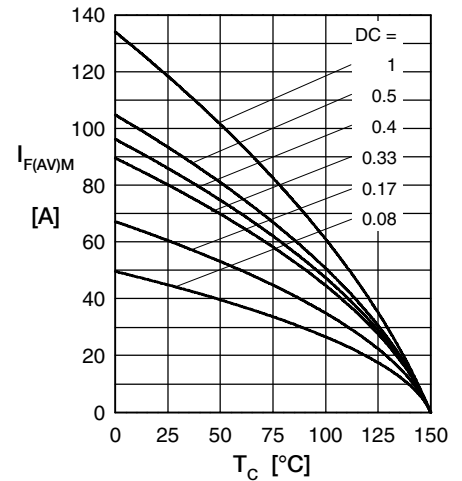

Fig. 5 Max. forward current vs. case temperature

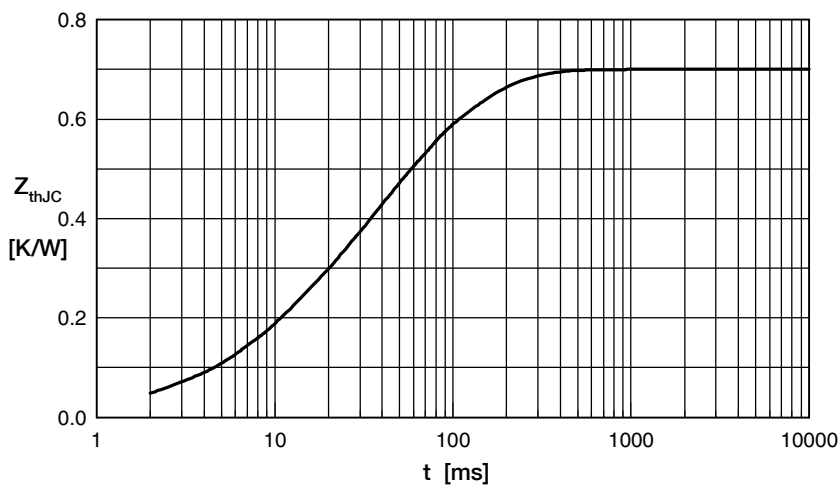

Fig. 6 Transient thermal impedance junction to case

Constants for Z_{thJC} calculation:

i	R_{th} (K/W)	t_i (s)
1	0.09	0.012
2	0.05	0.007
3	0.32	0.036
4	0.24	0.102