

# Standard Rectifier Module

<b>3~ Rectifier</b>	
$V_{RRM}$ =	800 V
$I_{DAV}$ =	105 A
$I_{FSM}$ =	750 A

## 3~ Rectifier Bridge

Part number

**VUO98-08NO7**

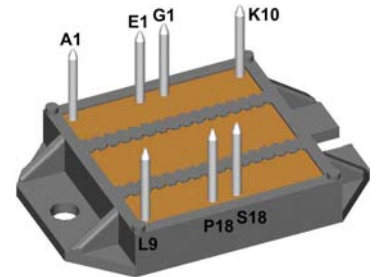

E72873

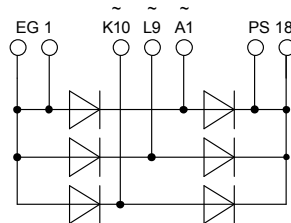

### Features / Advantages:

- Package with DCB ceramic
- Improved temperature and power cycling
- Planar passivated chips
- Very low forward voltage drop
- Very low leakage current

### Applications:

- Diode for main rectification
- For three phase bridge configurations
- Supplies for DC power equipment
- Input rectifiers for PWM inverter
- Battery DC power supplies
- Field supply for DC motors

### Package: ECO-PAC2

- Industry standard outline
- RoHS compliant
- Soldering pins for PCB mounting
- Height: 9 mm
- Base plate: DCB ceramic
- Reduced weight
- Advanced power cycling

Rectifier				Ratings		
Symbol	Definition	Conditions	min.	typ.	max.	Unit
$V_{RSM}$	max. non-repetitive reverse blocking voltage	$T_{VJ} = 25^{\circ}C$			900	V
$V_{RRM}$	max. repetitive reverse blocking voltage	$T_{VJ} = 25^{\circ}C$			800	V
$I_R$	reverse current	$V_R = 800 V$	$T_{VJ} = 25^{\circ}C$		100	$\mu A$
		$V_R = 800 V$	$T_{VJ} = 150^{\circ}C$		1.5	mA
$V_F$	forward voltage drop	$I_F = 40 A$	$T_{VJ} = 25^{\circ}C$		1.14	V
		$I_F = 120 A$			1.48	V
		$I_F = 40 A$	$T_{VJ} = 125^{\circ}C$		1.06	V
		$I_F = 120 A$			1.51	V
$I_{DAV}$	bridge output current	$T_C = 115^{\circ}C$ rectangular $d = \frac{1}{3}$	$T_{VJ} = 150^{\circ}C$		105	A
$V_{FO}$	threshold voltage	} for power loss calculation only	$T_{VJ} = 150^{\circ}C$		0.81	V
$r_F$	slope resistance				5.9	m $\Omega$
$R_{thJC}$	thermal resistance junction to case				0.7	K/W
$R_{thCH}$	thermal resistance case to heatsink			0.3		K/W
$P_{tot}$	total power dissipation		$T_C = 25^{\circ}C$		175	W
$I_{FSM}$	max. forward surge current	$t = 10 \text{ ms}; (50 \text{ Hz}), \text{ sine}$	$T_{VJ} = 45^{\circ}C$		750	A
		$t = 8,3 \text{ ms}; (60 \text{ Hz}), \text{ sine}$	$V_R = 0 V$		810	A
		$t = 10 \text{ ms}; (50 \text{ Hz}), \text{ sine}$	$T_{VJ} = 150^{\circ}C$		640	A
		$t = 8,3 \text{ ms}; (60 \text{ Hz}), \text{ sine}$	$V_R = 0 V$		690	A
$I^2t$	value for fusing	$t = 10 \text{ ms}; (50 \text{ Hz}), \text{ sine}$	$T_{VJ} = 45^{\circ}C$		2.82	kA <sup>2</sup> s
		$t = 8,3 \text{ ms}; (60 \text{ Hz}), \text{ sine}$	$V_R = 0 V$		2.73	kA <sup>2</sup> s
		$t = 10 \text{ ms}; (50 \text{ Hz}), \text{ sine}$	$T_{VJ} = 150^{\circ}C$		2.05	kA <sup>2</sup> s
		$t = 8,3 \text{ ms}; (60 \text{ Hz}), \text{ sine}$	$V_R = 0 V$		1.98	kA <sup>2</sup> s
$C_J$	junction capacitance	$V_R = 400 V; f = 1 \text{ MHz}$	$T_{VJ} = 25^{\circ}C$		11	pF

Package ECO-PAC2		Ratings				
Symbol	Definition	Conditions	min.	typ.	max.	Unit
$I_{RMS}$	RMS current	per terminal			100	A
$T_{stg}$	storage temperature		-40		125	°C
$T_{VJ}$	virtual junction temperature		-40		150	°C
<b>Weight</b>				24		g
$M_D$	mounting torque		1.5		2	Nm
$d_{Spp/App}$	creepage distance on surface   striking distance through air	terminal to terminal	6.0			mm
$d_{Spb/Apb}$		terminal to backside	10.0			mm
$V_{ISOL}$	isolation voltage	t = 1 second	3000			V
		t = 1 minute 50/60 Hz, RMS; $I_{ISOL} \leq 1$ mA	2500			V

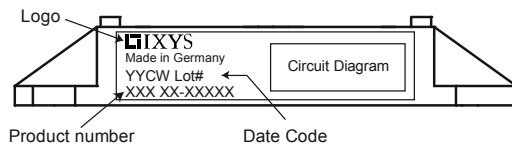

Ordering	Part Number	Marking on Product	Delivery Mode	Quantity	Code No.
Standard	VUO98-08NO7	VUO98-08NO7	Box	25	494488

### Equivalent Circuits for Simulation

\* on die level

$T_{VJ} = 150^\circ\text{C}$



Rectifier

$V_{0\max}$	threshold voltage	0.81	V
$R_{0\max}$	slope resistance *	4.6	mΩ

Outlines ECO-PAC2

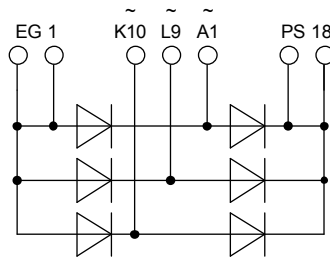
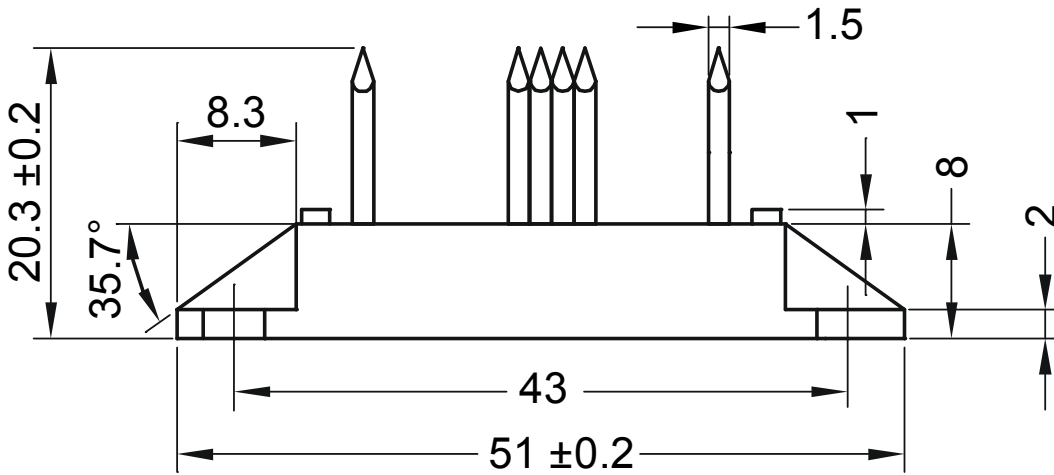
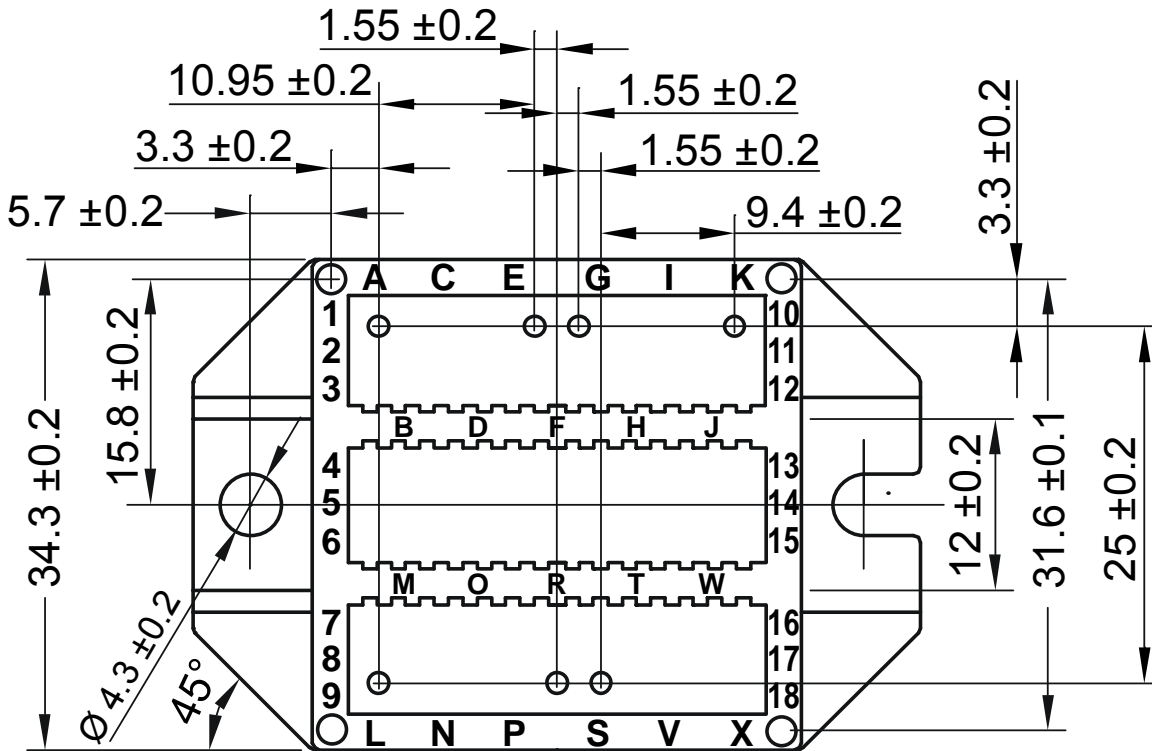

## Rectifier

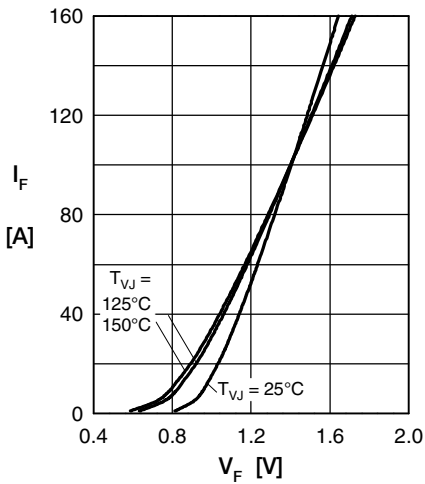

Fig. 1 Forward current versus voltage drop per diode

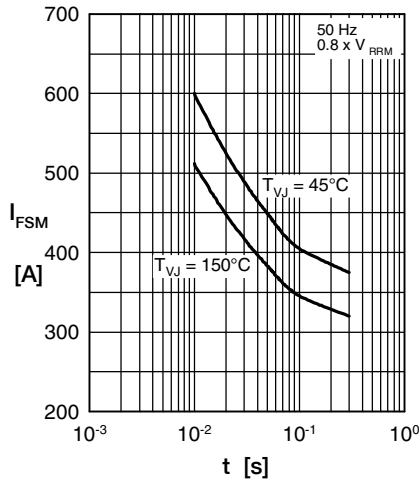

Fig. 2 Surge overload current

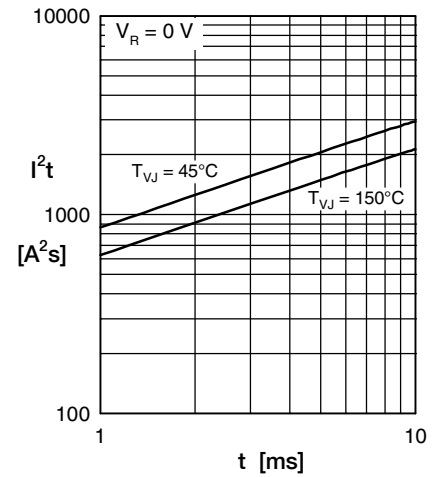

Fig. 3  $I^2t$  versus time per diode

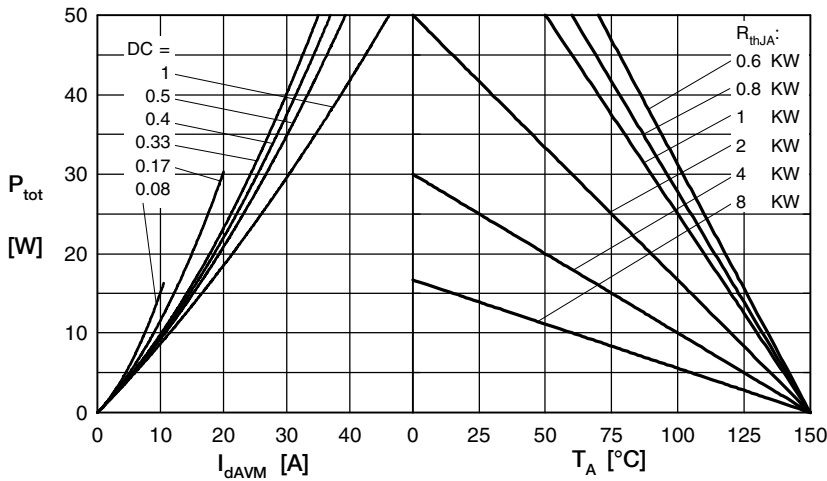

Fig. 4 Power dissipation vs. direct output current & ambient temperature

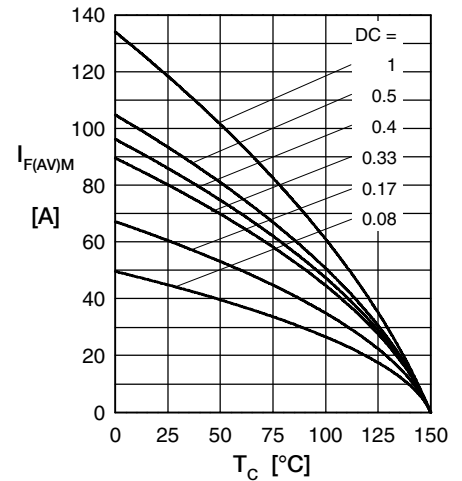

Fig. 5 Max. forward current vs. case temperature

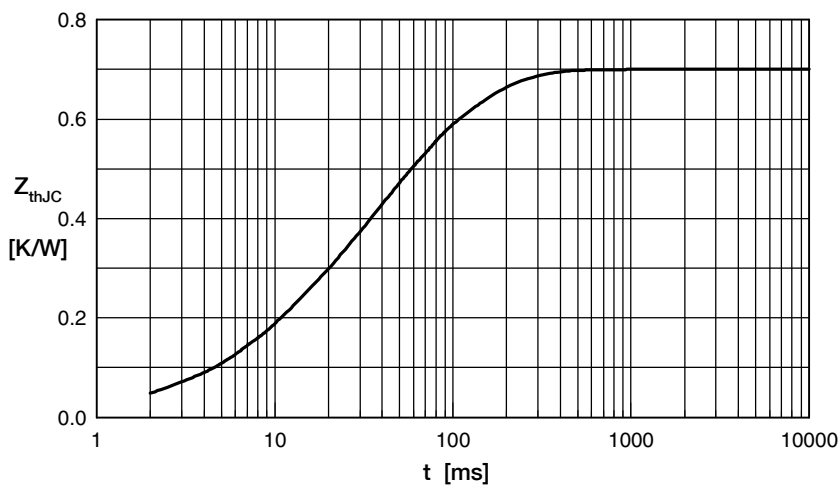

Fig. 6 Transient thermal impedance junction to case

Constants for  $Z_{thJC}$  calculation:

i	$R_{th}$ (K/W)	$t_i$ (s)
1	0.09	0.012
2	0.05	0.007
3	0.32	0.036
4	0.24	0.102